



The Alternative Source

OCTOBER 2013
VOLUME 10 NO 2

The Leader in Replacement Parts for Healthcare Equipment Since 1972

PM Kits and More for Dental Compressors!

RPI has you in mind with these new parts to help with regularly scheduled service.

In keeping with our tradition of providing handy Planned Maintenance Kits for a vast array of medical and dental equipment, **RPI is pleased to now offer 56 PM Kits to service a variety of dental compressors.**

These PM Kits provide a convenient all-in-one-package set of parts to do regularly scheduled service on the most popular dental office compressors (both lubricated and oil-less models) manufactured by Air Techniques, Custom Air, Apollo, Midmark®, DentalEZ®, RamVac, Jun-Air, and Tech West.

For years, RPI has carried compressor oil and critical parts you need most for dental compressors. And now with the introduction of many new parts this year, RPI is your one-stop-shop for dental compressor PM Kits.

Depending on the number of heads and filter assemblies on the make and model of the compressors, RPI customizes each Kit to include the precise number of air intake and coalescing filter elements needed. Also included in Kits for the lubricated models are oil, an oil disposal bag, and, where needed, the rib cover and drain plug gaskets.

Each Kit includes a PM checklist, providing valuable information on the

Continued on the back page

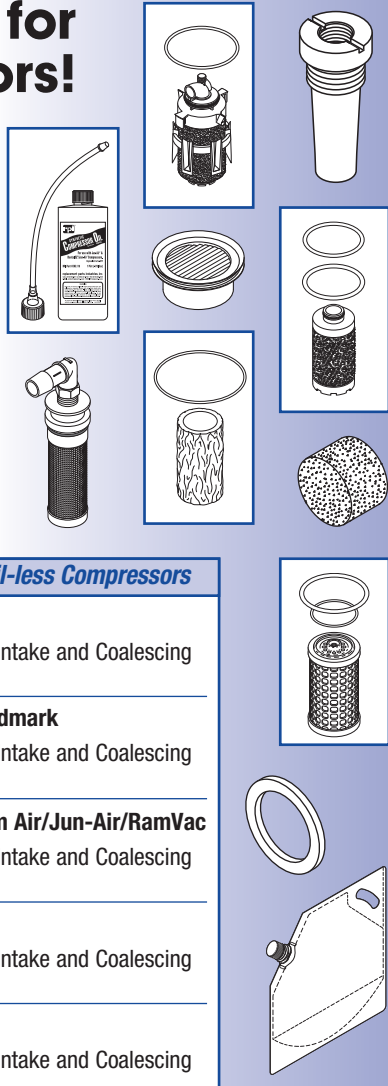

PM Kits For Oil-less Compressors

Air Techniques

Kits include Air Intake and Coalescing Filter Elements

Apollo/Matrx/Midmark

Kits include Air Intake and Coalescing Filter Elements

DentalEZ/Custom Air/Jun-Air/RamVac

Kits include Air Intake and Coalescing Filter Elements

Midmark

Kits include Air Intake and Coalescing Filter Elements

Tech West

Kits include Air Intake and Coalescing Filter Elements

PM Kits For Lubricated Compressors

Apollo/Matrx/Midmark

Kits include Air Intake and Coalescing Filter Elements, Oil, and Disposal Bag

DentalEZ/Custom Air/Jun-Air/RamVac

Kits include Air Intake and Coalescing Filter Elements, Oil, Disposal Bag, Rib Cover Gasket, and Drain Plug Gasket

Midmark

Kits include Air Intake and Coalescing Filter Elements, Oil, and Disposal Bag

Tech West

Kits include Air Intake and Coalescing Filter Elements, Oil, and Disposal Bag

RPI PART #AMK183 Updated Solenoid Valve Repair Kit Now Fits Two Different Valve Bodies!

By Phil Goldstein, RPI Product Development

Recently we made a change to our Solenoid Valve Repair Kit (**RPI Part #AMK183**) that fits Amsco/Steris and Castle/Getinge bulk sterilizers. You might have noticed that we have added an additional spring to our Kit. We did this so that this repair kit can now be used for servicing two different Amsco/Steris valve bodies.

One of the springs included in this kit is individually packaged with a label that clearly states that the spring is to be used only when repairing the Exhaust Manifold Assembly on Amsco/Steris Medium Century sterilizers (OEM Part #764326-482).

While the spring that is vacuum packed with the other parts is to be used when servicing the Solenoid Valve Assembly used in Amsco 2000 and 3000 Series sterilizers (OEM Part #764187-001).

One Kit, two options – it's the RPI Advantage!

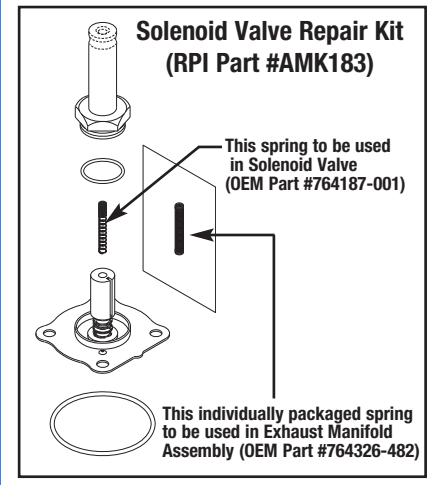



*Ira Lapidès
CEO & President
Replacement Parts Industries, Inc.*

FROM THE DESK OF THE PRESIDENT

From the time I was 9 years old I was helping my parents at RPI. Initially, I stuffed, stamped, and sealed envelopes for RPI’s first mailing. Later, when I was in middle school and high school and during those summers in between, I would ride my bike to RPI to help package parts. I learned some good lessons in those days about the value of hard work and what it was like to earn a paycheck. Observing others at work and how they conducted themselves and interacted also provided valuable lessons. I was also able to spend some good time with my parents, and understand better what they did at work each day.

Since the time I took over the reins at RPI over 14 years ago, I have tried to offer the same opportunity to the children of our employees here, having many come into RPI to work during their summer breaks, and hoping that they learn many of these same lessons. This past summer we had three different middle and high school aged children of employees work one or two days each week in our warehouse, packaging parts and helping to pull parts for orders.

We also, for the first time, brought in an intern into our engineering department for the summer, Keegan Fitzpatrick. He is an Eagle Scout from my son’s Boy Scout Troop, and is off to start his college education in mechanical engineering at the University of Colorado this fall. Keegan was able to spend time with our Drafting, Product Development, and Quality Assurance staff learning and assisting a variety of tasks and skills, and completing some much needed projects in those areas.

I have never forgotten the opportunities that I was presented and lessons that I learned, and do my best to continue to provide those same opportunities and pass on those same lessons. I hope that you are somehow able to do the same in your business. It is a great thing to be able to do for someone looking for experience.

On a different note, you may have noticed a bit of a change in the cross reference sections of our catalog. In the update that we mailed a few months ago, we changed the cross reference section to more of a table of contents for those particular sections, providing OEM, model, and page reference. The cross reference to OEM numbers is more easily accessed and kept up-to-date on our website, especially as some parts fit multiple OEM’s or have been given multiple part numbers by OEM’s over their lifespan. Look for the cross references in the remaining catalog sections to be updated early next year.

Also, look for more improvements coming soon to our website, including some upgrades to our General Shop Aids section to make it easier to identify the hardware in each of the different categories. We recently completed this for our power cords in that section. Our Tech Support area will also be seeing a bit of a makeover, making it easier to find documents for specific pieces of equipment. Like everything else at RPI, we are constantly looking for ways to improve our business and service to our customers, and so we continue to work to improve our website.

THE RPI FAMILY

My name is Angelina Kush and I have been a part of the RPI family for the last year and a half. I was born in northern California. I am the second oldest out of seven kids.

My step-dad was a part of the Navy and being a navy “brat” I had many wonderful opportunities while growing up. I remember being able to go aboard the USS Carl Vinson and hang out with my Dad.

In my spare time I sing and love to write poetry. My daughter is my inspiration and forces me to be better than what I already am.

I love the beach and often go to clear my head and that is where most of my poetry and songs come from. I am working on a “Poetry Book” of things that I have overcome and hoping to have it published in the next couple of years.



*Angelina Kush
Customer Service*

I also work with Middle and High School students as a Mentor. I have been working with this age group for the last five years. I am so blessed and thankful that I am able to give back and to help in any way I can. Another huge influence in my life is my Church where I teach twice a month. I enjoy teaching very much and try to give back by helping teens from single family households.

Most of my days are spent at my church and with my beautiful daughter – I wouldn’t have it any other way. I am so thankful and appreciative to RPI for welcoming me into a wonderful establishment. Looking forward to many, many years to come and grow.

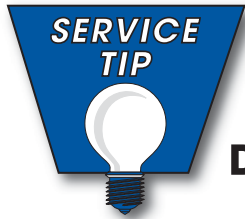

How to Manually Open the Pelton & Crane Magnaclave Door When the Power Goes Out

By Phil Goldstein, RPI Product Development

If the door on a Pelton & Crane Magnaclave sterilizer cannot be opened due to a power failure, there are several precautions and steps to take should you want to open it manually. Please see below.

How to Manually Open the Door.

IMPORTANT

Precautions in Steps #1-3 must be taken before removing the sterilizer casing in Step #4.

1. Disconnect power to the machine before attempting to open the door manually.
2. Make sure the machine cools down so you can touch the internal components without getting burned.
3. Actuate the Safety Release Valve and make sure all pressure is released.
4. Viewed from the front, remove the right side casing from the machine.
5. Locate the door handle - *see Figure 1*. Raise the door handle lever until it stops then hold it in that position. This is the first stop.
6. With the handle raised, reach in the machine and press the solenoid plunger in and hold in position - *see Figure 2*.
7. With the solenoid plunger pressed in, raise the door handle until it stops again and continue holding it in this position. This is the second stop.
8. Release the solenoid plunger.
9. Press the black Door Release button on the front of the machine (*see Figure 3*) and raise the door handle for the third time until it stops.
10. The door will disengage from the latch, and now can be opened.
11. Replace the right side casing.
12. Reconnect power to the machine.

FIGURE 1

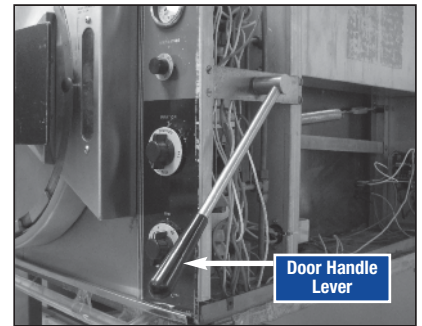

FIGURE 2

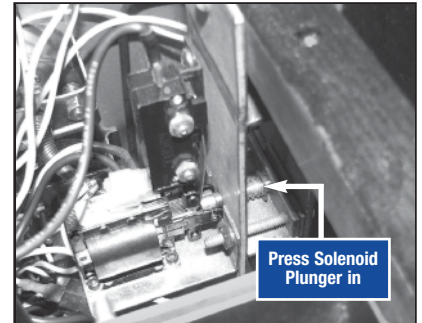
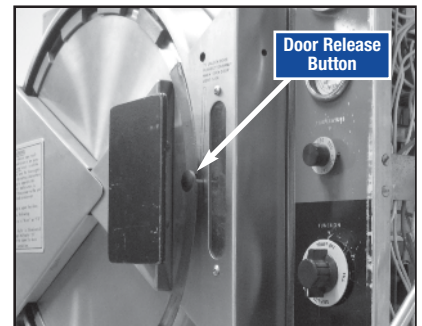

FIGURE 3



Repackaged for Easy Use! Heat Sink Compound (RPI Part #RPC464)

By Neil Blagman, RPI Product Development

When we decided to include the Heat Sink Compound (RPI Part #RPC464) with some of our new parts, we thought of the technicians' convenience by packaging the compound in a single-use squeeze tube with a snip-off spout that allowed pinpoint dispersal of the product. We thought it was a great idea.

However, some of our customers told us that the opening in the snip-off spout was so restrictive that it took too much pressure to dispense the thick compound. In addition, the flow rate was so slow that cutting off the crimp end of the tube was required – which turned a good idea into an inconvenience.

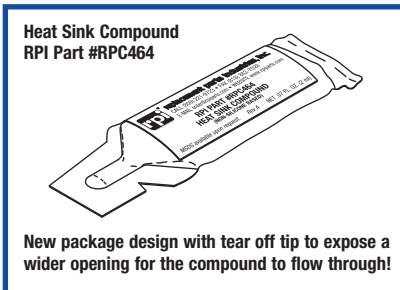

So we went back to the "drawing board" and changed our packaging to a "pillow" style pack. This new pack can be opened by simply tearing off the tip of the tube (*ahh! no scissors required*) to expose a wider opening for the compound to flow through, thus making the material much easier to dispense.

Look for our newly redesigned packages of Heat Sink Compound (RPI Part #RPC464) – still available in packages of 5 (.25 oz.) single-use packs.

You asked for it ... you got it! And, thank you for your feedback. We greatly appreciate it.

WHAT'S NEW

The following new parts are now in stock,



DENTAL COMPRESSOR PARTS - To fit Air Techniques, Apollo/Matrx/Midmark®, Midmark®, DentalEZ®/Custom Air/Jun-Air/RamVac, & Tech West

AUTO-DRAIN

RPI Part #CMD108
 OEM Part #JA4087602/4087602
 Fits: DentalEZ/Custom Air/Jun-Air/RamVac compressors*

AUTO DRAIN

RPI Part #CMD111
 OEM Part # (No OEM Part # Available)
 Fits: Tech West compressors*

CARBON FILTER ELEMENT

RPI Part #CME104
 OEM Part #4080500/64800-213
 Fits: DentalEZ/Custom Air/Jun-Air/RamVac compressors*

COALESCING FILTER ELEMENT

RPI Part #CME105
 OEM Part #4081600/64800-214
 Fits: DentalEZ/Custom Air/Jun-Air/RamVac compressors*

COALESCING FILTER ELEMENT

RPI Part #CME110
 OEM Part #CFE0-375
 Fits: Tech West compressors*

DIFFERENTIAL PRESSURE IND.

RPI Part #CMI106
 OEM Part #JA4087700/4087700
 Fits: DentalEZ/Custom Air/Jun-Air/RamVac compressors*

FILTER ELEMENT

RPI Part #CME102
 OEM Part #87367
 Fits: Air Techniques Membrane Dryers*

FILTER ELEMENT

RPI Part #CME103
 OEM Part #87336
 Fits: Air Techniques Membrane Dryers*

FILTER ELEMENT

RPI Part #CME107
 OEM Part #JA4081602/4081602
 Fits: DentalEZ/Custom Air/Jun-Air/RamVac compressors*

DRAIN PLUG GASKET

RPI Part #CMG197
 OEM Part #JA6235000/6235000
 Fits: DentalEZ/Custom Air/Jun-Air/RamVac compressors*

O-RING (RIB COVER GASKET)

RPI Part #RP0848
 OEM Part #JA6244000/6244000
 Fits: DentalEZ/Custom Air/Jun-Air/RamVac compressors*

OIL PLUG

RPI Part #CMP196
 OEM Part #JA7167000/7167000
 Fits: DentalEZ/Custom Air/Jun-Air/RamVac compressors*

PRESSURE SWITCH

RPI Part #CMS131
 OEM Part #77005143
 Fits: Matrx/Midmark and Midmark compressors*

SYNTHETIC COMPRESSOR OIL

RPI Part #CML119
 OEM Part #JA64651-004/64651-004
 • Also sold by the Case of 12 bottles (RPI Part #CML120)
 Fits: DentalEZ/Custom Air/Jun-Air/RamVac compressors*

* Please see our website www.rpiparts.com for a complete list of models these parts fit.



DENTAL COMPRESSOR TOOLS - - To fit Air Techniques, Apollo/Matrx/Midmark®, Midmark®, DentalEZ®/Custom Air/Jun-Air/RamVac, & Tech West

Completely removes oil from the compressor!

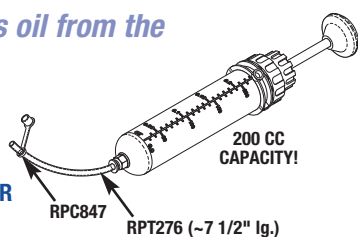

SYRINGE PUMP/EXTRACTOR

RPI Part #RPT842
 OEM Part # (No OEM Part # Available)
 • 200 CC capacity
 • This essential tool allows complete removal of oil from a compressor without needing to tilt or disassemble the unit - It's the RPI Advantage!

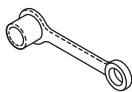

CAP

RPI Part #RPC847
 OEM Part # (No OEM Part # Available)
 • Fits 1/4" O.D. tubing

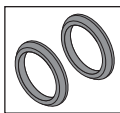

SEAL KIT

RPI Part #RPK846
 OEM Part # (No OEM Part # Available)
 • For use with Syringe Pump/Extractor (RPI Part #RPT842)

Gives you complete control while draining oil!

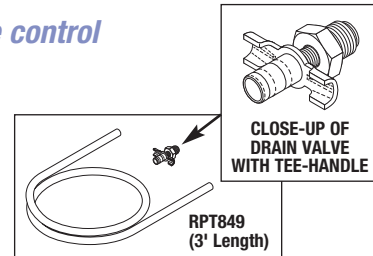

DRAIN VALVE

RPI Part #RPV841
 OEM Part #PVV50525 (Plug)
 • Replace the existing drain plug with RPI's new Drain Valve and make your next compressor oil change a breeze! RPI's Drain Valve has a special Tee-handle that allows you to easily open and close the valve to control the flow of oil as it is draining into the Disposal Bag - It's the RPI Advantage!



DISPOSAL BAG

RPI Part #RPB838
 OEM Part # (No OEM Part # Available)
 • RPI's one gallon bag is constructed of durable clear plastic with an expandable base, a built in handle, and tight sealing cap. It's the perfect solution for carrying, storing and disposing of used oil!

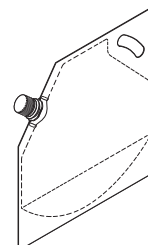

FROM RPI

ready to ship the day your order is received!



DENTAL COMPRESSOR PM KITS - To fit Air Techniques, Apollo/Matrx/Midmark®, Midmark®, DentalEZ®/Custom Air/Jun-Air/RamVac, & Tech West

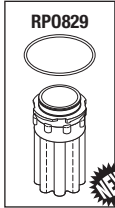

FILTER ELEMENT
RPI Part #CME102

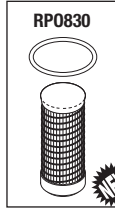

FILTER ELEMENT
RPI Part #CME103

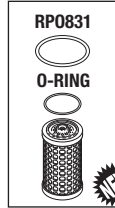

FILTER ELEMENT
RPI Part #CME104

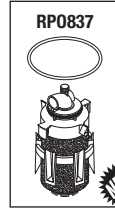

FILTER ELEMENT
RPI Part #CME107

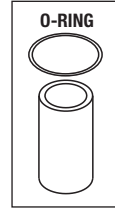

**REPLACEMENT
FILTER ELEMENT**
RPI Part #CME004

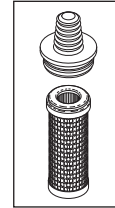

AIR FILTER ELEMENT
RPI Part #CME071



**SYNTHETIC
COMPRESSOR OIL**
RPI Part #CML119



**AIR FILTER
ELEMENT**
RPI Part #CME069



COMPRESSOR OIL
RPI Part #CML001



**AIR FILTER
ELEMENT**
RPI Part #CME067

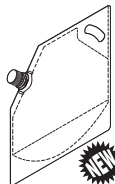

DISPOSAL BAG
RPI Part #RPB838



**AIR FILTER
ELEMENT KIT**
RPI Part #CMK065

To make your life easier, we took these

24 Parts to Create

56 Compressor PM Kits

to fit **9** OEMs!

Air Techniques, Apollo/Matrx/Midmark®, Midmark®, DentalEZ®/Custom Air/Jun-Air/RamVac & Tech West



**INTAKE
FILTER ELEMENT**
RPI Part #CME074



FOAM ELEMENT
RPI Part #CMF013



INTAKE FILTER
RPI Part #CMF075

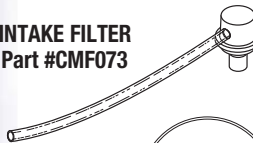

AIR INTAKE FILTER
RPI Part #CMF073



**O-RING
(RIB COVER GASKET)**
RPI Part #RP0848



DRAIN PLUG GASKET
RPI Part #CMG197



**COALESCING
FILTER ELEMENT**
RPI Part #CMK024

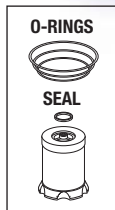

**COALESCING
FILTER ELEMENT**
RPI Part #CMK025

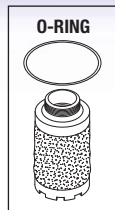

**COALESCING
FILTER ELEMENT**
RPI Part #CME043

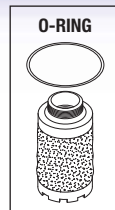

**COALESCING
FILTER ELEMENT**
RPI Part #CME044

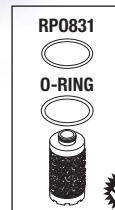

**COALESCING
FILTER ELEMENT**
RPI Part #CME105

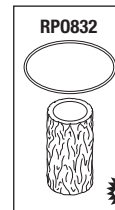

**COALESCING
FILTER ELEMENT**
RPI Part #CME110

RPI's Compressor PM Kits include all the necessary Air Intake Filters, Coalescing Filter Elements, Accessories and Oil you need for regularly scheduled maintenance of your dental compressor. For more information please see our website www.rpiparts.com.



8 to 4
NO MORE

Sherry Lapidès
Vice President, Customer Relations
Replacement Parts Industries, Inc.

Ira, Al and I were talking the other day and the subject came up about how we started RPI and the changes that have occurred in the company in the past 40 years.

Many of you have heard the story of how Ira and his brother and sister would sit in front of the TV while they were paid a penny per piece to stuff, seal and stamp our first mailers. What I may not have mentioned, though, is that we built our first mailing list from scratch by going to the Los Angeles main library and the telephone company office, looking through the yellow pages and copying names and addresses of companies we thought might be interested in an alternate source for parts to repair medical equipment. At that time, I didn't even realize that dental offices had some of the same sterilizers. I then typed those names and addresses onto labels and used them for our mailings. Back then, we didn't know you could buy mailing lists.

We really were proud when we bought our first computer in the early 1980s. Phil Goldstein loved the fact that he no longer had to keep inventory records by hand. I liked the fact that typos were easier to correct and that sales were automatically posted to customers' accounts, rather than being recorded by hand. I guess the purchase of a fax machine was our next electronic milestone. Once again, here was something that helped move things along faster.

In the RPI early years, most of our customers contacted us via the telephone. I really enjoyed talking with them when they called to place an order. Some nice friendships developed over the phone, and Al and I were lucky over the years to meet some of you and match up faces and voices.

Today our computer system is so sophisticated no one will let me near it. Ira, Joan and Dora work with our hardware and software support people, and I am out of that loop. Our website was up-and-running in 1996. Most recently, we added our shopping cart feature and it is enjoyed by many of our customers. And to think, when we first started on the computer, I didn't even know what a website was.

I remember being at an industry meeting years ago where

Continued on the back page

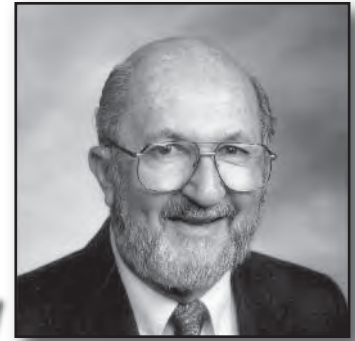

AL'S VIEW

Al Lapidès
CEO Emeritus & Chairman of the Board
Replacement Parts Industries, Inc.

FROM THE OLD CURMUDGEON (still)

It was old home week at the AAMI (American Association for Medical Instrumentation) meeting this year. Sherry and I had a reunion with a few of the people who helped level the playing field for all people in the biomed engineering and service fields. This includes those in the dental field because what they did impacted all of us. Only some 50 years ago or so, biomedical and clinical engineering were not yet totally professional. Servicing and maintaining equipment were primarily within the purview of the OEMs using only their parts. That began to change with the arrival of some of these people on the scene.

Malcolm Ridgeway made a huge impact on the quality of service. He began developing standards that equipment must meet. He even developed the methodology to attain those standards. He continued contributing as a vice-president of MasterPlan. Although he has now officially entered the ranks of the retired, he has continued in his quest for quality and performance to this day.

Jack Spears was a real pioneer. As I recall, he was an experienced biomed engineer when he realized that there was no communication or source for communication between and for biomed. About the time that we started RPI, he started a tiny publication for the industry. It was printed on newsprint and looked somewhat homemade. But its contents were excellent. It was so good that it grew into the magazine, 24 X 7. It is the must read publication for all in the service business. Today he is still in the business of keeping those in the service business informed.

Ray Dalton started one of the first major independent service organizations for hospital equipment. He started and sold a few companies and has been operating PartsSource quite successfully for over ten years now.

Bensing Wang was another pioneer. He was an executive in a couple of companies that are involved with service and maintenance. He recently retired as a vice president at Aramark and is now offering his services to the industry as a consultant. He is still working very hard to further level the playing field.

Continued on the back page

TECH TALK

3 New Tools to Make Changing the Oil a Breeze!

By Mark Micucci, RPI Product Development

When it's time to change the oil in a dental compressor – don't sweat it! RPI has three new tools that will help make the job easier than ever before!

New Tool #1. We are pleased to offer the perfect solution for carrying, storing, and disposing of used oil – it's our one gallon **Disposal Bag (RPI Part #RPB838)**. Our bag is constructed of durable clear plastic so you can easily see when it is full to avoid nasty overflows. It also has an expandable base to help stabilize it as it is being filled to help prevent it from tipping over. Plus, transporting the messy oil is a snap with the built in handle and

tight sealing cap. (Just be sure to properly dispose of all collected used oil as required by law, and according to local, state and government regulations.)

New Tool #2. Replace the existing drain plug with RPI's new, one-of-a-kind **Drain Valve (RPI Part #RPV841)** to make your next oil change a breeze. RPI's Drain Valve has a special Tee-handle that allows you to easily open and close the valve to control the flow of oil as it is draining into the disposal bag. This new part can really save you time and money.

New Tool #3. *Question:* What looks like an oversized syringe with a capacity of 200 CC's, and 7-1/2" of tubing instead of a needle? *Answer:* It's the new RPI user friendly tool that allows complete removal of old oil from a compressor without needing to tilt or disassemble the unit! The **RPI Syringe Pump/Extractor (RPI Part #RPT842)** is essential to helping make the job of removing oil at the bottom of the unit quicker and safer!

RPI is always looking for ways to make your job easier. It's the RPI Advantage!



At RPI we truly have the best parts warranty in the industry! Basically, our parts are guaranteed to your complete satisfaction.

So if, for whatever reason, you believe one of our parts has not met your complete satisfaction, you simply contact us for a replacement. It's really that simple. However, there is just one thing we ask of you.

If you need to return an RPI part that you have already installed, and the part has wires connected into a housing, such as a motor or time switch, **please do not cut the wires to remove the part prior to returning it to us.** Doing so could void the warranty on that part.



When the wires are cut, we cannot do anything with that part except toss it in the scrap heap, as those wires connect inside a housing and cannot be replaced. If the wires are cut, the part is useless to us since there is no way that we can evaluate it when it comes back to us

We simply ask that you send the part back to us whole so that we can evaluate the problem to ensure that it does not happen again. And, if we can fix the part, we will usually donate it to a medical or dental mission organization that could use it.

Look at it this way – you need to remove the terminals from the connectors anyway, so do us a favor, and don't cut the wires. We appreciate your help. Thank you.

3 New tools for an easier oil change!

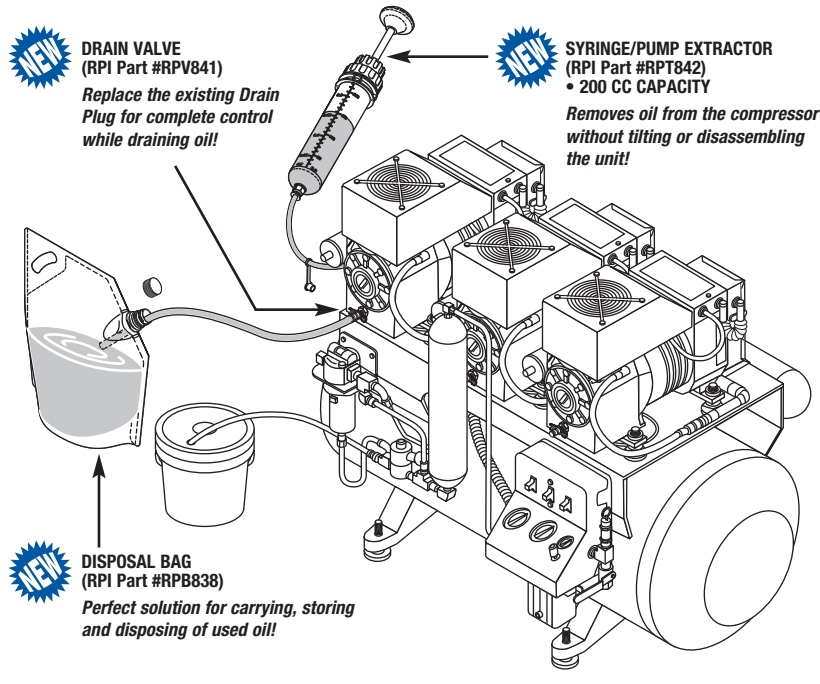



replacement parts industries, inc.

"The Alternate Source®"

P.O. Box 5019, Chatsworth, CA 91313-5019

PRSRT STD
US Postage
PAID
Van Nuys, CA
Permit #2399

Especially for . . .

PM Kits and Much More for Dental Compressors!

(Continued from front page)

installation of each item. The checklists are available on the RPI website to be downloaded, as is a chart of all of the PM Kits. Keep the chart handy as it includes all of the RPI PM Kits for dental compressors. What's more, the chart lists the Kits by make and model, making it easy to find the Kit you need at a glance.

In addition, PM stickers for each filter element are included, as well as a PM Kit sticker to serve as a reminder as to when the elements were last changed so that you can easily keep track of the next scheduled planned maintenance for each compressor that you service.

And, don't forget the Compressor Maintenance Guide that you can cus-

tomize with your name and phone number to provide to your customers, helping them to keep their compressors running smoothly. We now offer a Compressor Maintenance Guide for oil-less units as well.

With this new offering of PM Kits, we are also introducing SJ-27 synthetic oil (which includes a convenient, long tube connected to the cap for ease of filling the compressor), several additional coalescing filter elements, and other handy accessories.

RPI is also pleased to introduce three new tools that are designed specifically to help make changing the oil in a dental compressor a much easier task – saving you time and money.

Our new tools include a drain valve with tubing for quick and easy draining, a syringe pump/extractor that allows you to extract all of the old, used oil out of a compressor, and a handy disposal bag (which is included in all the Compressor PM Kits designed for compressors with oil) to drain the old oil into.

Please take a moment to read more about these tools in our Tech Talk article, "3 New Tools to Make Changing the Oil a Breeze", on page 7.

We have even more parts to fit dental compressors in the works, so keep a lookout for our bright yellow new parts flyers and check the New Parts Index on our website for updates!

AI's View

(Continued from page 6)

Sherry and I hadn't seen these "old timers" for quite some time. This was a wonderful time to visit and catch up with some great people.

As old timers do, we reminisced about many of the things we had been through. While many shades of grey have come in, it is refreshing to know that none of them have lost their love for the industry, nor their efforts to continue to improve it.

8 to 4 No More

(Continued from page 6)

service companies were talking about a wonderful new device called the "Blackberry", and how great a help it was with communications and with scheduling service calls and relaying information.

In those early days, no one thought of or anticipated how cell phones would come along and drastically change how business is done or their effect on personal relationships.

I don't know what the next great invention will be that will come along and change the way business is done, but that anticipation is one of the things that keeps us going. I hear that there is a Dick Tracy-like wrist cell phone on the market already. I can't wait to see what the future will bring.

I hope all of you had a wonderful summer and will enjoy the upcoming holiday season.

All rights reserved. No part of this newsletter may be reproduced or utilized in any form or by any other means without permission in writing from the Publisher. Inquiries should be addressed to: RPI, Marketing Department, P.O. Box 5019, Chatsworth, California 91313-5019. Additional copies of The Alternate Source® may be obtained by contacting RPI. Please feel free to Call: (800) 221-9723, Fax: (818) 882-7028, or E-Mail: moreinfo@rpi.com your request. Parts mentioned in this newsletter are manufactured by Replacement Parts Industries, Inc. to fit the equipment noted. All product names used in this document are trademarks or registered trademarks of their respective holders. RPI © 2013.

**CALL (800) 221-9723 or (818) 882-8611 • FAX (818) 882-7028 • WEBSITE www.rpiparts.com
E-MAIL moreinfo@rpi.com • E-MAIL order@rpi.com • E-MAIL techhelp@rpi.com**