

Models: Advantage®, Advantage Plus®, CER Optima®, DSD-91E®, DSD-201®, DSD Edge®, & SSD-102®

STERILIZERS – MINNTECH (MEDIVATORS)

New Line of Parts to fit

MEDIVATORS®

DSD-201® & DSD-Edge® AER Systems!

RPI Part #MTA001
OEM Part #MF01-0028



AIR FILTER ASSEMBLY

- 8 per package
- 0.2 micron
- 50mm filter media disc
- 1/4" flow male quick coupling (Blue-Inlet) and (White-Outlet)
- Includes: Tubing (3/8" ID x .594" OD Clear Braided) (RPI Part #RPT879)

Fits: Air Compressor Line

Models: Advantage, Advantage Plus, CER Optima, DSD-91E, DSD-201, DSD Edge, & SSD-102

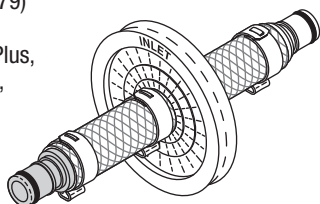

RPI Part #MTF004
OEM Part #MF01-0015



PREFILTER CARTRIDGE (0.45 MICRON ABSOLUTE)

- Size: 2.55" OD x 10" lg.
- Silicone O-Rings

Fits: Incoming Water Line

Models: Advantage, DSD-91E, DSD-201, DSD Edge, & SSD-102

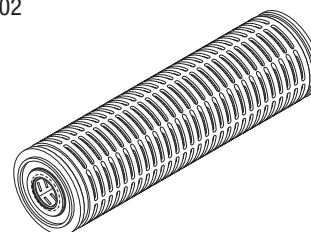

RPI Part #MTA002
OEM Part #MF01-0011



DISINFECTANT FILTER ASSEMBLY

- 12 per package
- 65 micron
- 1/4" flow male quick coupling (Red-Inlet) and (Grey-Outlet)
- Includes: Tubing (3/8" ID x .594" OD Clear Braided) (RPI Part #RPT879)

Fits: Disinfectant Line

Models: CER Optima, DSD-91E, DSD-201, & SSD-102

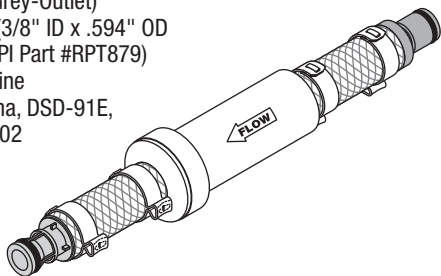

RPI Part #MTF005
OEM Part #MF01-0014



PREFILTER (1 MICRON)

- Size: 2-1/2" OD x 10" lg.

Fits: Pre Filter Assembly

Models: Advantage, Advantage Plus, CER Optima, DSD-91E, DSD-201, DSD Edge, & SSD-102

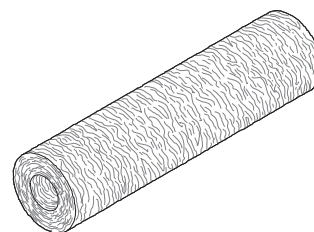

RPI Part #MTV030
OEM Part #41600-109



SOLENOID VALVE (MAC)

- 120VAC / 60 Hz., 5.4W (2.67k Ω), 110VAC / 50Hz., 5.4W (2.24k Ω)
- Material: Viton® seals
- 18" lg.; #22 AWG wire
- Includes mounting screws
- Also available: Coil (Solenoid Valve - MAC) (RPI Part #MIC032) and Elbow Fitting (5/32" PUSH-IN x #10-32 MALE) (RPI Part #RPF986)

Fits: Air Delivery System

Models: DSD-201 & DSD Edge

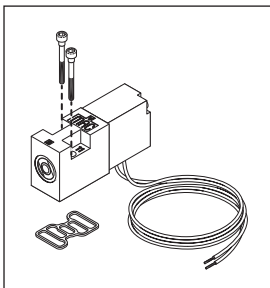

RPI Part #MTC032
OEM Part # (No OEM Part # Available)



COIL (SOLENOID VALVE - MAC)

- 120VAC / 60 Hz., 5.4W (2.67k Ω), 110VAC / 50Hz. (5.4W, 2.24k Ω)
- 18" lg.; #22 AWG wires
- Includes mounting screws
- Also available: Solenoid Valve (MAC) (RPI Part #MTV030)

Fits: Air Delivery System

Models: DSD-201 & DSD Edge

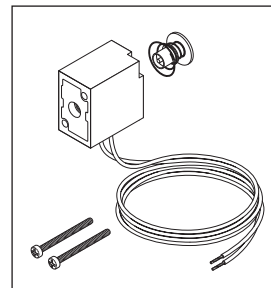

replacement parts industries, inc.

CALL (800) 221-9723 • FAX (818) 882-7028 • EMAIL order@riparts.com • WEBSITE www.riparts.com

The above parts are manufactured by Replacement Parts Industries, Inc. to fit the equipment noted. All product names used in this document are trademarks or registered trademarks of their respective holders. Flyer Code 1705MT Rd #1 Show 01/18



RPI Part #MTP025
OEM Part #78400-689



PUMP (DISINFECTANT)

- 115 VAC, 60 Hz
- Includes: 10" lg. wires with ferrite and connector

Fits: Chassis
Models: DSD-201 & DSD Edge

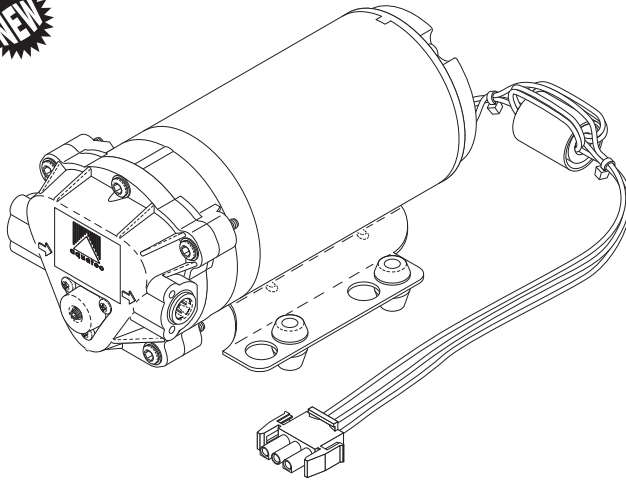

RPI Part #MTS048
OEM Part #47049-415



SPRING

- 4 per package
 - Size: .240" OD x .513" lg.
 - Material: Stainless steel
- Fits:** SSG Dosing Assembly
Models: DSD Edge



RPI Part #MTV027
OEM Part #78401-260



CHECK VALVE

- Includes: (8) Check Valves and (16 pcs) Viton® O-ring (RPI Part #RPO326)
- Cracking Pressure: 1.60 PSI
- Material: Polycarbonate
- Size: 5/8" OD x 5/8" lg.

Fits: Fluid Manifold
Models: DSD-201 & DSD Edge

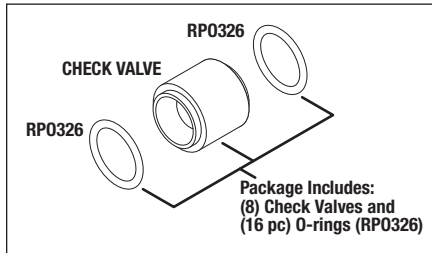

RPI Part #MTS024
OEM Part #MT010-0500



PERISTALTIC PUMP TUBING SET

- 4 per package
 - Size: 10.0" lg.
- Fits:** Peristaltic Pump
Models: DSD-201 & DSD Edge

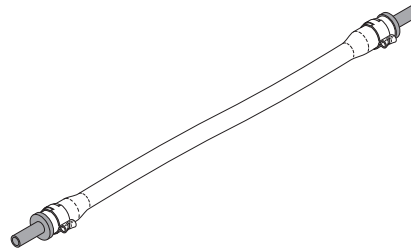

RPI Part #MTB047
OEM Part #47049-658 & 47049-416



FLOAT BALL

- 4 per package
 - Size: .250" dia.
 - Material: Viton®
- Fits:** SSG Dosing Assembly
Models: DSD Edge



RPI Part #MTV028
OEM Part #MV01-0040



CHECK VALVE (ALCOHOL AND DETERGENT)

- 2 per package
- Cracking Pressure: .057 PSI
- Material: Orange Silicone
- Size: .43" dia. x .82" lg.
- Temperature Range: -60°C to +175°C

Fits: Alcohol and Detergent Assembly
Models: DSD-201 & DSD Edge



RPI Part #MTS044
OEM Part #43100-254



STRAINER

- 2 per package
 - Size: 1.00" dia. x 1.35" lg. wire mesh
 - Material: 80 mesh 316 stainless steel
- Fits:** Disinfectant Manifold
Models: DSD Edge

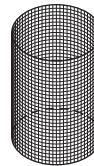

RPI Part #RPO983
OEM Part #43100-224
Industry Part #AS568-133



O-RING

- 3 per package
 - Size: 1.799" ID x 2.005" OD x .103" C/S
 - Material: Viton® (FKM), 75 Duro, Black
- Fits:** Drain Manifold Valves
Models: DSD-201 & DSD Edge

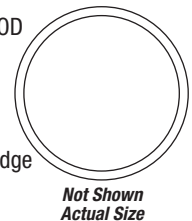

RPI Part #MTC029
OEM Part #MC13-0015



COVER (BASIN SENSOR)

- 2 per package
- Material: Clear PETG
- Size: ~1.60" dia.

Fits: Basin Sensor
Models: DSD-201 & DSD Edge

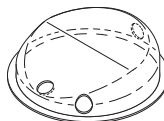

RPI Part #MTS045
OEM Part #41013-001



SEAL (SAMPLE PORT)

- 2 per package
 - Material: Viton®
 - Size: 1.17" dia. x .28" H
- Fits:** Sample Port Valve
Models: DSD Edge



RPI Part #RPO984
OEM Part #M001-0004



O-RING

- 6 per package
 - Material: Viton®, 75 Duro
 - Size: 1.176" ID x 1.316" OD x 0.70" C/S
- Fits:** Drain Manifold
Models: DSD-201 & DSD Edge

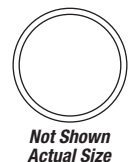

RPI Part #RXF012
OEM Part # (No OEM Part # Available)
MALE CONNECTOR
 (3/8" PUSH-IN x 1/4" MPT)
 • 2 per package
 • Material: Nickel plated brass
 • Includes PTFE sealing ring
Fits: Air Tank Assembly
Models: DSD-201 & DSD Edge

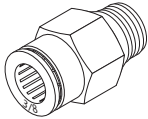

RPI Part #RXF013
OEM Part # (No OEM Part # Available)
ELBOW FITTING
 (3/8" PUSH-IN x 1/8" MPT)
 • 2 per package
 • Material: Nickel plated brass
Fits: 4 Station Air/Valve Manifold
Models: DSD-201 & DSD Edge

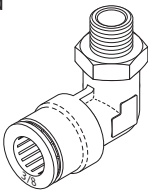

RPI Part #RXF014
OEM Part # (No OEM Part # Available)
ELBOW FITTING
 (3/8" PUSH-IN x 1/4" MPT)
 • 2 per package
 • Material: Nickel plated brass
 • Includes PTFE sealing ring
Fits: MAC Solenoid Valve Manifold Assemblies
Models: DSD-201 & DSD Edge

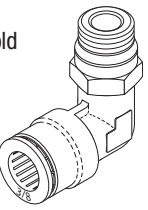

RPI Part #RXF015
OEM Part # (No OEM Part # Available)
MALE CONNECTOR
 (5/32" PUSH-IN x 1/8" MPT)
 • 8 per package
 • Material: Nickel plated brass
 • Includes PTFE sealing ring
Fits: MAC Valve Assemblies
Models: DSD-201 & DSD Edge

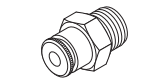

RPI Part #RPT987
OEM Part #MT01-0000 (4" lg.)
TUBING
 (1" ID x 1-1/4" OD CLEAR PVC)
 • Sold by the foot (reel not included)
Fits: 1" Barb Fitting
Models: DSD-201

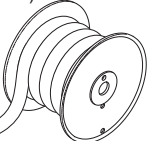

RPI Part #RPT879
OEM Part # (No OEM Part # Available)
TUBING
 (3/8" ID x .594" OD CLEAR BRAIDED)
 • Sold by the foot. Reel not included
 • Temperature range: +25°F to +150°F
 • Pressure range: @ 77°F 225 PSI
 • Included in: Air Filter Assembly (RPI Part #MTA001) and Disinfectant Filter Assembly (RPI Part #MTA002)
Fits: 3/8" Barb
Models: DSD-201 & DSD Edge

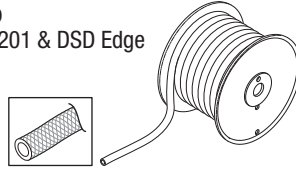

RPI Part #RPT959
OEM Part #MT01-0024
TUBING
 (1/4" ID x 3/8" OD CLEAR POLYETHYLENE)
 • Sold by the foot (reel not included)
Fits: 3/8" Push-In Fitting, 3/8" Polyfilo Fitting or 1/4" Barb Fitting
Models: DSD-201 & DSD Edge

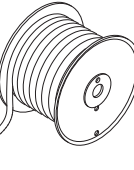

RPI Part #RXT009
OEM Part #MT01-0026
TUBING
 (.170" ID x 1/4" OD NATURAL TRANSLUCENT)
 • Sold by the foot (reel not included)
Fits: 1/4" Push-In Fittings
Models: DSD-201 & DSD Edge

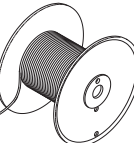

RPI Part #RXT010
OEM Part #MT01-0025
TUBING
 (.106" ID x 5/32" OD BLACK)
 • Sold by the foot (reel not included)
Fits: 5/32" Push-In Fittings
Models: DSD-201 & DSD Edge

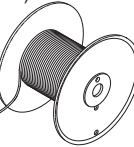

RPI Part #RXT011
OEM Part #47509-390
TUBING
 (.106" ID x 5/32" OD ORANGE)
 • Sold by the foot (reel not included)
Fits: 5/32" Push-In Fittings
Models: DSD-201 & DSD Edge

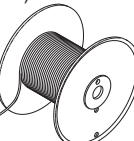

RPI Part #RXC021
OEM Part # (No OEM Part # Available)
KWIK™ CLAMP (.59" - .67" DIA)
 • 6 per package
 • Material: Nylon®; Color: Black
 • Clamping range: (.59" - .67" dia.)
 • Temperature range: -40°F to 302°F
Fits: 5/8" OD Tubing
Models: DSD-201 & DSD Edge

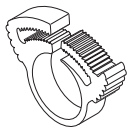

RPI Part #RXC022
OEM Part # (No OEM Part # Available)
KWIK™ CLAMP (1.26" - 1.37" DIA)
 • 6 per package
 • Material: Nylon®; Color: Black
 • Clamping range: (1.26" - 1.37" dia.)
 • Temperature range: -40°F to 302°F
Fits: 1-1/4" OD Tubing
Models: DSD-201 & DSD Edge

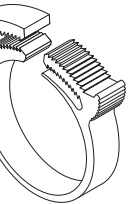

RPI Part #RXT003
OEM Part #MW03-0002
WRENCH (LOW PROFILE)
 • Material: Stainless steel
 • Double Ended Flat Wrench: 7/16" x 10mm
 • Used to secure the valve stem flat on Medivators pneumatic valve
Models: DSD-201 & DSD Edge

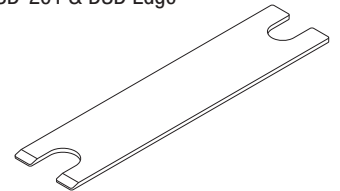

RPI Part #RXT004
OEM Part #47049-157
COLLET RELEASE WRENCH SET
 • John Guest collet wrench set
 • Sizes: 3/16", 1/4", 5/16", 3/8" and 1/2"
Fits: Tubing Fittings
Models: DSD-201 & DSD Edge

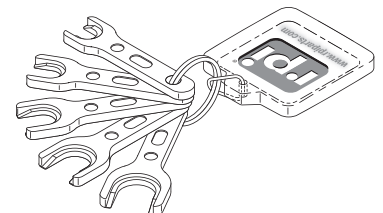



replacement parts industries, inc.

20338 Corisco Street • Chatsworth, California • 91311

PRESORTED STANDARD
U.S. POSTAGE PAID
VAN NUYS, CA
PERMIT NO. 2399

ADDRESS SERVICES REQUESTED

New Line of Parts to fit Medivators® DSD-201® & DSD Edge® AER Systems!

Complete List of RPI Parts to fit

**MEDIVATORS®
Automated Endoscope Reprocessors!**

RPI Part #	OEM Part #	Description	Advantage	Advantage Plus	CER Optima	DSD-91E	DSD-201	DSD Edge	SSD-102
MTA001	MF01-0028	Air Filter Assembly - 8/PKG	•	•	•	•	•	•	•
MTA002	MF01-0011	Disinfectant Filter Assembly - 12/PKG			•	•	•		•
MTB047	47049-658	Float Ball - 4/PKG						•	
MTC029	MC13-0015	Cover (Basin Sensor) - 8/PKG					•	•	
MTC032	<i>No OEM Part # Available</i>	Coil (Solenoid Valve - MAC)					•	•	
MTF004	MF01-0015	Prefilter Cartridge (0.45 Micron Absolute)	•			•	•	•	•
MTF005	MF01-0014	Prefilter (1 Micron)	•	•	•	•	•	•	•
MTK046	43100-302	O-Ring Kit						•	
MTP025	78400-689	Pump (Disinfectant)					•	•	
MTS024	MT010-0500	Peristaltic Pump Tubing Set - 4/PKG					•	•	
MTS044	43100-254	Strainer - 2/PKG						•	
MTS045	41013-001	Seal (Sample Port) - 2/PKG						•	
MTS048	47049-415	Spring - 8/PKG						•	
MTV027	78401-260	Check Valve - 8/PKG					•	•	
MTV028	MV01-0040	Check Valve (Alcohol and Detergent) - 2/PKG					•	•	
MTV030	41600-109	Solenoid Valve (MAC)					•	•	
RPO983	43100-224	O-Ring - 3/PKG					•	•	
RPO984	MO01-0004	O-Ring - 3/PKG					•	•	
RPT879	<i>No OEM Part # Available</i>	Tubing (3/8" ID x .594" OD Clear Braided) - per foot					•	•	
RPT959	MT01-0024	Tubing (1/4" ID x 3/8" OD Clear Polyethylene) - per foot					•	•	
RPT987	MT01-0000 (4" lg.)	Tubing (1" ID x 1-1/4" OD Clear PVC) - per foot					•		
RXC021	<i>No OEM Part # Available</i>	Kwik™ Clamp (.59" - .67" dia.) - 6/PKG					•	•	
RXC022	<i>No OEM Part # Available</i>	Kwik™ Clamp (1.26" - 1.37" dia.) - 6/PKG					•	•	
RXF012	<i>No OEM Part # Available</i>	Male Connector (3/8" Push-In x 1/4" MPT) - 2/PKG					•	•	
RXF013	<i>No OEM Part # Available</i>	Elbow Fitting (3/8" Push-In x 1/8" MPT) - 2/PKG					•	•	
RXF014	<i>No OEM Part # Available</i>	Elbow Fitting (3/8" Push-In x 1/4" MPT) - 2/PKG					•	•	
RXF015	<i>No OEM Part # Available</i>	Male Connector (5/32" Push-In x 1/8" MPT) - 8/PKG					•	•	
RXT003	MW03-0002	Wrench (Low Profile)					•	•	
RXT004	47049-157	Collet Release Wrench Set					•	•	
RXT009	MT01-0026	Tubing (.170" ID x 1/4" OD Natural Translucent) - per foot					•	•	
RXT010	MT01-0025	Tubing (.106" ID x 5/32" OD Black) - per foot					•	•	
RXT011	47509-390	Tubing (.106" ID x 5/32" OD Orange) - per foot					•	•	