

Air Techniques, Apollo/Midmark®, DentalEZ®/Custom Air/RamVac, MatrX/Midmark®, & Midmark®

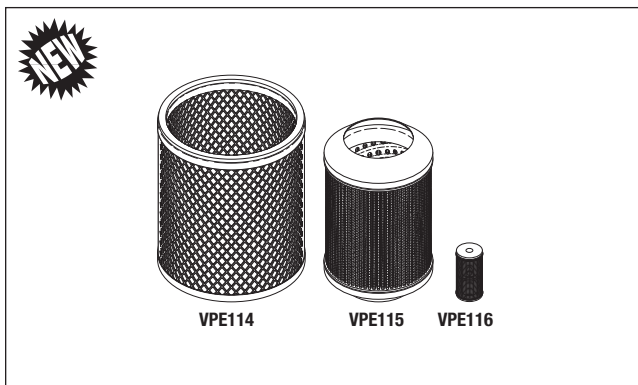

More New Parts to fit Dental Vacuum Units!



RPI Part #VPK113
OEM Part #003740

Also Available: Synthetic Oil
(RPI Part #VPL131) - See Below!

FILTER KIT

- See **Service Tip** below
 - Includes all parts as shown
- Fits:** Vacuum Controller Assembly

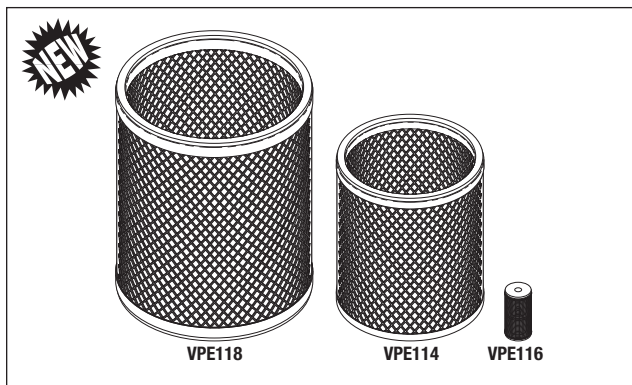

RPI Part #VPK117
OEM Part #003750

Also Available: Synthetic Oil
(RPI Part #VPL131) - See Below!

FILTER KIT

- See **Service Tip** below
 - Includes all parts as shown
- Fits:** Vacuum Controller Assembly

RPI Part #VPE116
OEM Part #310705

Also Available: Synthetic Oil
(RPI Part #VPL131) - See Below!

OIL FILTER ELEMENT

- Size: .78" OD x 1.62" lg.
 - Material: 200 Mesh stainless steel and 2 Nitrile (Buna N) O-rings
 - See **Service Tip** below
 - Includes: PM Sticker
- Fits:** Vacuum Controller Assembly



RPI Part #VPE114
OEM Part #003550SP

FILTER ELEMENT

- 5 Micron
 - Size: 4.56" OD x 5.36" lg.
 - See **Service Tip** below
 - Includes: PM Sticker
- Fits:** Vacuum Controller Assembly

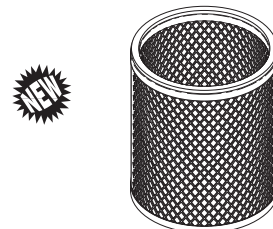

RPI Part #VPE115
OEM Part #003548SP

FILTER ELEMENT

- 3 Micron
 - Size: 3.40" OD x 5.15" lg.
 - See **Service Tip** below
 - Includes: PM Sticker
- Fits:** Vacuum Controller Assembly

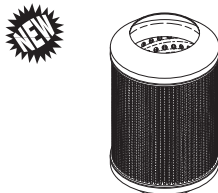

RPI Part #VPE118
OEM Part #003549SP

FILTER ELEMENT

- 5 Micron
 - Size: 6.00" OD x 7.45" lg.
 - See **Service Tip** below
 - Includes: PM Sticker
- Fits:** Vacuum Controller Assembly



RPI Part #VPL131
OEM Part # (No OEM Part # Available)

- SYNTHETIC OIL (MOBIL 1®)**
- Size: 1 Quart (.946 Liter) bottle
 - 15W-50 (ISO grade 32)



– ALSO AVAILABLE BY THE CASE OF 6 BOTTLES!

RPI Part #VPL132

Service Tip: Air filter life depends on vacuum usage, nature of environment, and amount of aspirated material. Inspect air filter every 1,000 hours and replace every 2,000 hours or when visibly dirty. Also, inspect the oil filter every 1,000 hours and change the oil filter element every 2,000 hours or when changing the oil.

Air Techniques, Apollo/Midmark®, DentalEZ®/Custom Air/RamVac, MatrX/Midmark®, & Midmark®

DENTAL VACUUM UNITS –

SECTION

4

PAGE

1711

UPDATED

08/16

For more information about the parts listed in this flyer, see our website www.rpiparts.com



replacement parts industries, inc.

CALL (800) 221-9723 • FAX (818) 882-7028 • EMAIL order@rpiparts.com • WEBSITE www.rpiparts.com

The above parts are manufactured by Replacement Parts Industries, Inc. to fit the equipment noted. All product names used in this document are trademarks or registered trademarks of their respective holders. 1510VP Show 08/16



RPI Part #VPA125
OEM Part #002-1448-00

FLOAT ASSEMBLY (NEW)

- 2 Float Switches
- **Service Tip:** Earlier versions of the PowerVac had three float switches, later PowerVac models and all PowerVac G models used two float switches. The middle float switch was for the liquid Evacuation Pump Option. If you have a liquid Evacuation pump connected to an earlier Power Vac you must replace the float assembly with a three Float Switch Assembly (RPI Part #VPA126). If there is no Evacuation pump connected to the PowerVac, you can replace the float with this version of the two float switch assembly.
- Includes: Two float switches with harness, float assembly bracket, PVC tank adaptor, cable gland and plug assembly with cable clamp.
- Also available: Float Assembly (Old) (RPI Part #VPA126)

Fits: Separator Tank

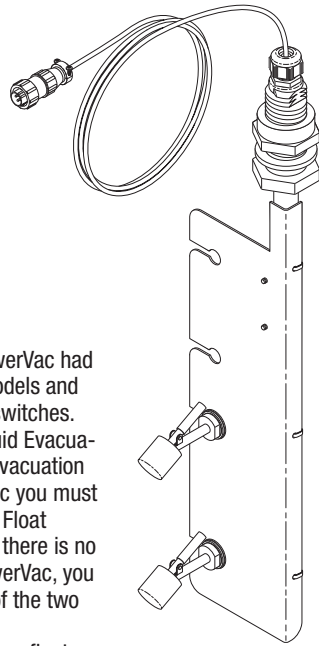

RPI Part #VPA126
OEM Part #015-2067-00

FLOAT ASSEMBLY (OLD)

- 3 Float Switches
- **Service Tip:** Earlier versions of the PowerVac had three float switches, later PowerVac models and all PowerVac G models used two float switches. The middle float was for the liquid Evacuation Pump Option. If you have a liquid Evacuation pump connected to an earlier Power Vac you can replace the float assembly with this three float switch assembly. If there is no Evacuation pump connected to the PowerVac, you can replace the float assembly with the two Float Switch Assembly (RPI Part #VPA125).
- Includes: Three float switches with harness, float assembly bracket, PVC tank adaptor, cable gland and plug assembly with cable clamp
- Also available: Float Assembly (New) (RPI Part #VPA125)

Fits: Separator Tank

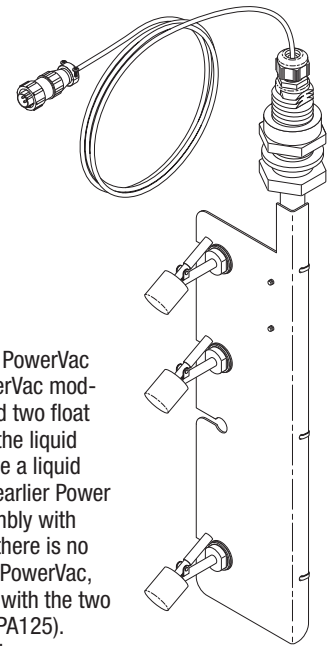

RPI Part #VPG106
OEM Part #053-1616-00

GASKET (SEPARATOR LID)

- Size: 12.62" OD X .46" thk.
 - Material: Nitrile (Buna N); 70 Duro
- Fits:** Separator Lid and Tank

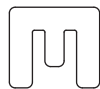
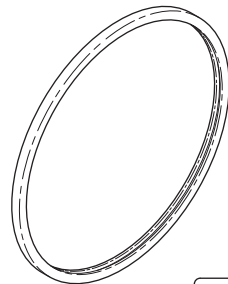

VPG106
CROSS SECTION
SHOWN ACTUAL SIZE



RPI Part #VPG108
OEM Part #65950000

FLANGE GASKET

- Size: 6.05" OD x .13" thk
 - Material: Nitrile (Buna N); 70 Duro
- Fits:** Separator Tank

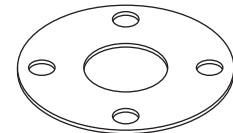

RPI Part #VPG107
OEM Part #053-2159-00

GASKET (SEPARATOR LID)

- Size: 21.50" OD x .34" thk.
 - Material: Nitrile (Buna N); 70 Duro
- Fits:** Separator Lid and Tank

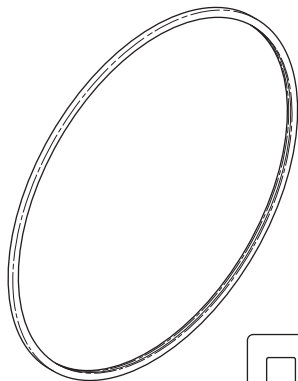

VPG107
CROSS SECTION
SHOWN ACTUAL SIZE



RPI Part #VPG109
OEM Part #54619

CAS COVER GASKET

- Size: 15.27" OD x .21" thk
 - Material: Nitrile (Buna N); 50 Duro with adhesive backing
- Fits:** CAS Cover (Cyclonic Action Separator)

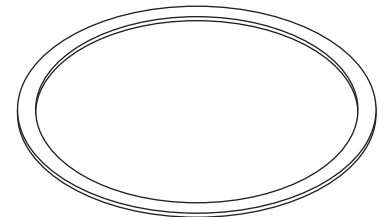

VPG109
CROSS SECTION
SHOWN ACTUAL SIZE

RPI Part #VPV124
OEM Part #029-3811-00



VACUUM RELIEF VALVE

- Material: Dark grey plastic
- Preset @ approx. 5 lb. (adjustable)
- Includes: Vacuum Relief Valve (1") (RPI Part #VPV060) and Foam Element (RPI Part #CMF013)

• See www.rpiparts.com for quantity required for each model

Fits: Separator Assembly

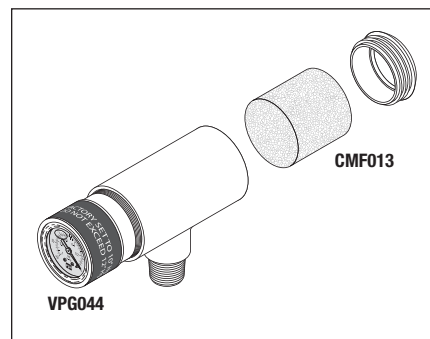
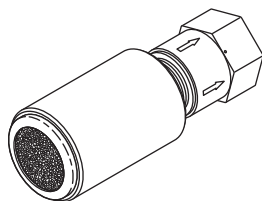

RPI Part #VPV141
OEM Part #77002144



VACUUM RELIEF VALVE (PLATFORM)

- Port: 3/4" MPT
- Material: PVC
- Includes: Vacuum Gauge (Liquid Filled) (RPI Part #VPG044) and Foam Element (RPI Part #CMF013)

Fits: Twin Intake Manifold Assembly or Platform Mount



RPI Part #VPA121
OEM Part #54660

DRAIN ASSEMBLY

- Includes: Check Valve (1-1/2") (RPI Part #VPV122)

Fits: Separator Tank

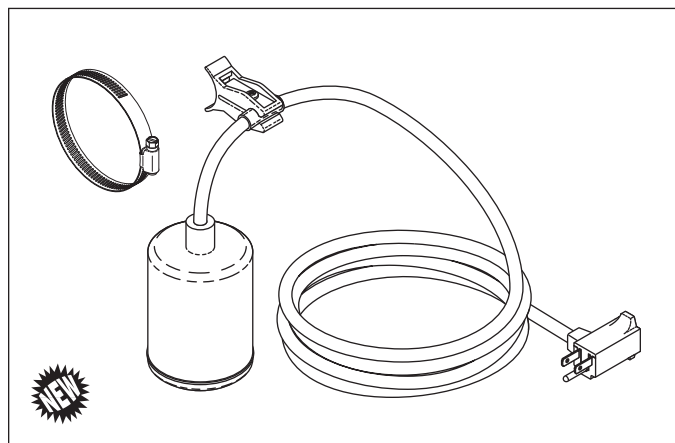
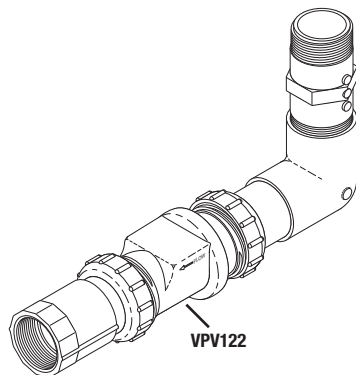

RPI Part #VPS130
OEM Part #62950500

FLOAT SWITCH (DIFFERENTIAL)

- 115VAC, N.O.
- Size: 3" dia. x 3" lg. float, with 10' lg. cable
- Includes: Hose clamp and pipe/cable clamp

Fits: Separator Tank



RPI Part #VPS129
OEM Part #62950600

FLOAT SWITCH (FAIL-SAFE)

- SPST; 24" lg.
- 1/2" MPT mounting thread
- Material: Polypropylene

Fits: Separator Tank

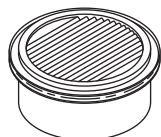
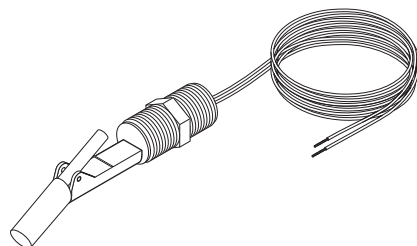

VPE111

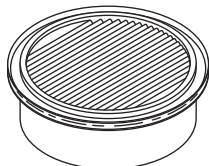

VPE112

RPI Part #VPK110
OEM Part #005301SP

FILTER KIT

- Includes: Filter Element (RPI Part #VPE111), Filter Element (RPI Part #VPE112) and PM Stickers

Fits: Vacuum Controller Assembly



RPI Part #VPE111
OEM Part #004691SP

FILTER ELEMENT

- 5 Micron polyester filter
- Size: 3.00" OD x 1.00" lg.
- Includes: PM Sticker
- Included in: Filter Kit (RPI Part #VPK110)

Fits: Vacuum Controller Assembly

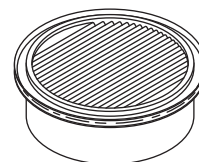

RPI Part #VPE112
OEM Part #004876SP

FILTER ELEMENT

- 5 Micron polyester filter
- Size: 4.00" OD x 1.38" lg.
- Includes: PM Sticker
- Included in: Filter Kit (RPI Part #VPK110)

Fits: Vacuum Controller Assembly

Don't Forget... RPI offers these parts and more to fit Dental Vacuum Units!

- Belt Tension Tester
- Brush Repair Kits
- Check Valves
- Drive Belts
- Pump Repair Kits
- Solid Collectors & Solid Collector Kits (3/4", 1", 1-1/4" & 1-1/2")
- Synthetic Oil
- Tank Washout Kits
- and more!



VPB098

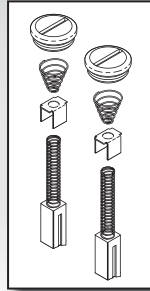

VPL131

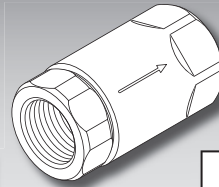

VPV119

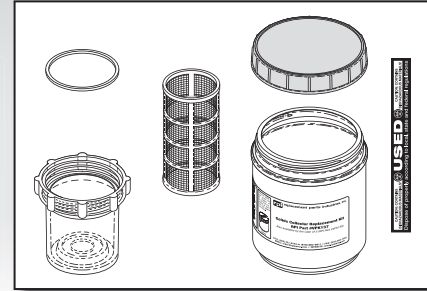

VPK137

New Parts to fit Air Techniques, DentalEZ®, Custom Air/RamVac, Matrix/Midmark®, & Midmark® Dental Vacuum Units!

ADDRESS SERVICES REQUESTED

PRESENTED STANDARD
U.S. POSTAGE PAID
VAN NUYS, CA
PERMIT NO. 2399

replacement parts industries, inc.
20338 Corisco Street • Chatsworth, California • 91311



More New RPI Parts to fit Dental Vacuum Units!

See our website www.rpiparts.com for specific models these parts fit!

RPI PART #	DESCRIPTION	AIR TECHNIQUES	DENTALEZ®/CUSTOM AIR/RAMVAC	MATRIX/MIDMARK®	MIDMARK®
VPA121	Drain Assembly	54660			
VPA125	Float Assembly (New)				002-1448-00
VPA126	Float Assembly (Old)				015-2067-00
VPE111	Filter Element		004691SP		
VPE112	Filter Element		004876SP		
VPE114	Filter Element		003550SP		
VPE115	Filter Element		003548SP		
VPE116	Oil Filter Element		310705		
VPE118	Filter Element		003549SP		
VPG106	Gasket (Separator Lid)				053-1616-00
VPG107	Gasket (Separator Lid)				053-2159-00
VPG108	Flange Gasket			65950000	
VPG109	CAS Cover Gasket	54619			
VPK110	Filter Kit		005301SP		
VPK113	Filter Kit		003740		
VPK117	Filter Kit		003750		
VPS129	Float Switch (Fail-Safe)			62950600	
VPS130	Float Switch (Differential)			62950500	
VPV124	Vacuum Relief Valve				029-3811-00
VPV141	Vacuum Relief Valve (Platform)			77002144	77002144