



**New parts to fit
Air Shields Isolette® C2000 Infant Incubators!**

RPI Part #AIP165
OEM Part #MU12397 (Overlay Only) & 83 020 67 (Overlay Only)

FRONT PANEL ASSEMBLY

- Overlay mounted to sheet metal frame
- Includes all parts as shown

Fits: Controller
Model: C2000

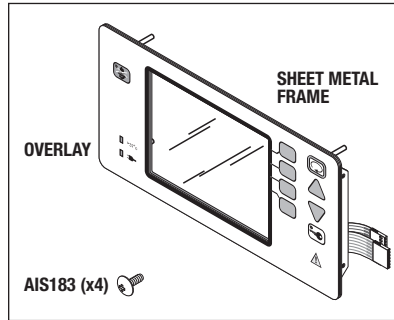

RPI Part #AIS183
OEM Part #MU15067 & 99 010 56

SCREW (#4-40 x 1/4)

- 4 per package
- Material: Stainless steel
- Size: #4-40 x 1/4" Ig. Phillips Truss Head Screw

Fits: Front Panel Assembly
Model: C2000

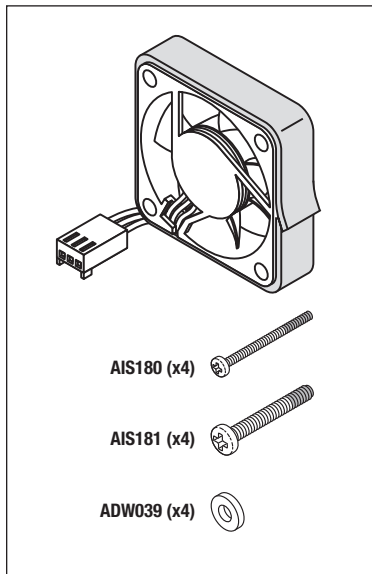

RPI Part #ADW039
OEM Part #MU15510 & 99 121 22

FLAT WASHER (#6)

- 15 per package
- Material: Nylon®
- .140" ID x .320" OD x .030" thk

Models: C2000 & Versalet® 7700



RPI Part #AIS180
OEM Part #MU15095 & 99 012 33

SCREW (#4-40 x 1)

- 4 per package
- Material: Stainless steel supplied with pre-applied thread locker
- Size: #4-40 x 1.0" Ig. Phillips Pan Head Screw

Models: C2000 & Versalet® 7700

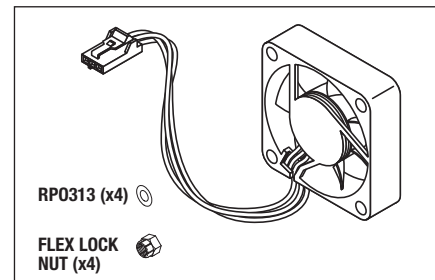

RPI Part #AIF158
OEM Part #MU12409 (Fan Only) & 83 020 91 (Fan Only)

FAN ASSY (CONTROLLER)

- Size: 1.575" x 1.575" x .413" fan housing
- 10.8 to 13.2 VDC; 4200 RPM
- Includes all parts as shown

Fits: Controller
Model: C2000



RPI Part #AIF157
OEM Part #MU12299 (Fan Only) & 83 005 46 (Fan Only)

FAN ASSY (SENSOR MODULE)

- Size: 1.575" x 1.575" x .413" fan housing
- 10.8 to 13.2 VDC; 4200 RPM
- Includes all parts as shown

Fits: Sensor Module
Models: C2000 & Versalet® 7700



RPI Part #AIS181
OEM Part #MU15153 & 99 024 98

SCREW (#6-32 x 15/16)

- 4 per package
- Material: Stainless steel supplied with pre-applied thread locker
- Size: #6-32 x 15/16" Ig. Phillips Pan Head Screw

Models: C2000 & Versalet® 7700



RPI Part #AIN169
OEM Part #MU15420 (1 Pc only) & 99 105 06 (1 Pc only)

WING NUT (#6-32)

- 6 per package
- Material: Stainless steel

Fits: Controller
Model: C2000



RPI Part #AIC156
OEM Part #MU12287 (Cable Only) & 83 005 30 (Cable Only)

SENSOR MODULE CABLE ASSY

- Length: ~32"
- Includes all parts as shown

Fits: Sensor Module
Models: C2000 & Versalet® 7700

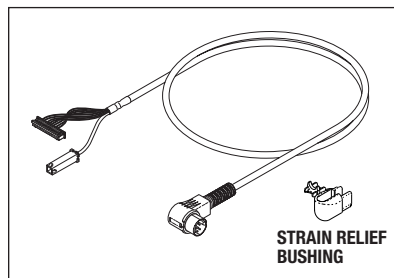

RPI Part #AIA159
OEM Part #MU12411 & 83 020 93

POWER SWITCH ASSEMBLY

- Switch: 8A @ 125VAC; DPDT

Fits: Controller
Model: C2000

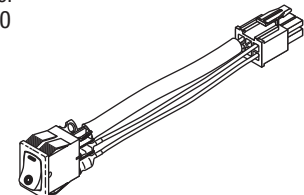

replacement parts industries, inc.

CALL (800) 221-9723 • FAX (818) 882-7028 • EMAIL order@rpiparts.com • WEBSITE www.rpiparts.com

The above parts are manufactured by Replacement Parts Industries, Inc. to fit Air Shields•Hill-Rom•Drager equipment. All product names used in this document are trademarks or registered trademarks of their respective holders. Web 02/12

Infant Incubators

Model: Isolette® C2000



RPI Part #AIH151
OEM Part #MU12601 (Hinge Only)
& 83 200 11 (Hinge Only)

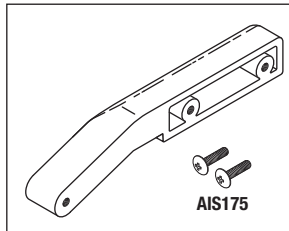

HINGE (HOOD) FRONT LEFT

- Includes all parts as shown
- Also available: Hinge (Access Panel) Front Left (RPI Part #AIH147) and Hinge Pin Kit (RPI Part #AIK167)

Fits: Hood Assembly
Model: C2000

RPI Part #AIH150
OEM Part #MU12600 (Hinge Only)
& 83 200 10 (Hinge Only)

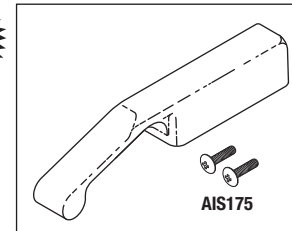

HINGE (HOOD) FRONT RIGHT

- Includes all parts as shown
- Also available: Hinge (Access Panel) Front Right (RPI Part #AIH146) and Hinge Pin Kit (RPI Part #AIK167)

Fits: Hood Assembly
Model: C2000

RPI Part #AIH153
OEM Part #MU12602 (Hinge Only)
& 83 200 12 (Hinge Only)

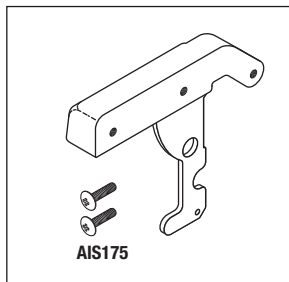

HINGE (HOOD) REAR LEFT

- Includes all parts as shown
- Also available: Hinge (Access Panel) Rear Left (RPI Part #AIH149) and Hinge Pin Kit (RPI Part #AIK167)

Fits: Hood Assembly
Model: C2000

RPI Part #AIH152
OEM Part #MU12603 (Hinge Only)
& 83 200 13 (Hinge Only)

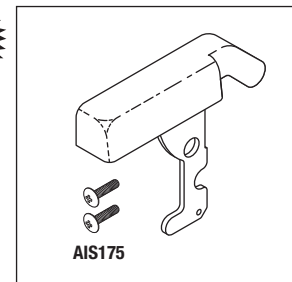

HINGE (HOOD) REAR RIGHT

- Includes all parts as shown
- Also available: Hinge (Access Panel) Rear Right (RPI Part #AIH148) and Hinge Pin Kit (RPI Part #AIK167)

Fits: Hood Assembly
Model: C2000

RPI Part #AIH149
OEM Part #MU12698 (Hinge Only)
& 83 300 35 (Hinge Only)

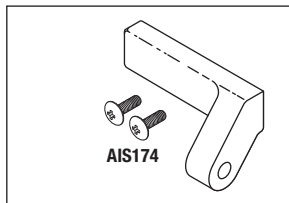

HINGE (ACCESS PANEL) REAR LEFT

- Includes all parts as shown
- Also available: Hinge (Hood) Rear Left (RPI Part #AIH152) and Hinge Pin Kit (RPI Part #AIK167)

Fits: Access Panel
Model: C2000

RPI Part #AIH148
OEM Part #MU12699 (Hinge Only)
& 83 300 36 (Hinge Only)

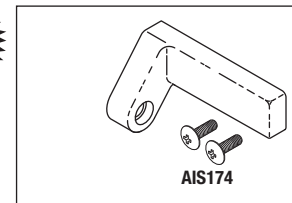

HINGE (ACCESS PANEL) REAR RIGHT

- Includes all parts as shown
- Also available: Hinge (Hood) Rear Right (RPI Part #AIH153) and Hinge Pin Kit (RPI Part #AIK167)

Fits: Access Panel
Model: C2000

RPI Part #AIH147
OEM Part #MU12695 (Hinge Only)
& 83 300 31 (Hinge Only)

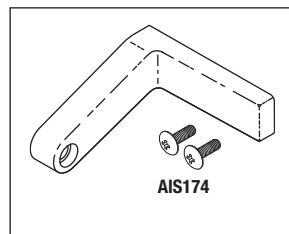

HINGE (ACCESS PANEL) FRONT LEFT

- Includes all parts as shown
- Also available: Hinge (Hood) Front Left (RPI Part #AIH151) and Hinge Pin Kit (RPI Part #AIK167)

Fits: Access Panel
Model: C2000

RPI Part #AIH146
OEM Part #MU12694 (Hinge Only)
& 83 300 30 (Hinge Only)

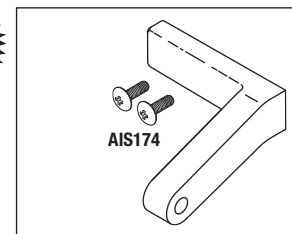

HINGE (ACCESS PANEL) FRONT RIGHT

- Includes all parts as shown
- Also available: Hinge (Hood) Front Right (RPI Part #AIH150) and Hinge Pin Kit (RPI Part #AIK167)

Fits: Access Panel
Model: C2000

RPI Part #AIK167
OEM Part #MU15729 (Shoulder Screw Only)
& 99 195 05 (Shoulder Screw Only)

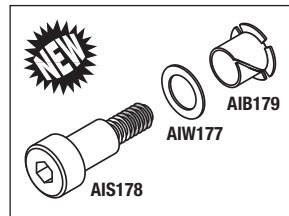

HINGE PIN KIT

- Includes all parts as shown
- Fits:** Hood Assembly
Model: C2000

RPI Part #AIS178
OEM Part #MU15729 & 99 195 05

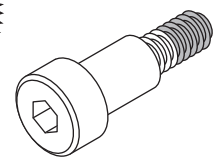

SHOULDER SCREW

- 2 per package
 - Material: Stainless steel supplied with pre-applied thread locker
 - Size: .250" dia. x .375" lg.; #10-24 Thread
- Model:** C2000

RPI Part #AIB179
OEM Part #MU12267 & 83 001 21



BEARING (FLANGED)

- 2 per package
 - Material: Nylon®
 - For .250" dia. shaft
- Model:** C2000

RPI Part #AIW177
OEM Part #MU15580 & 99 125 28



FLAT WASHER (1/4)

- 4 per package
 - Material: Nylon®
 - Size: .250" ID x .380" OD x .030" thk
- Model:** C2000

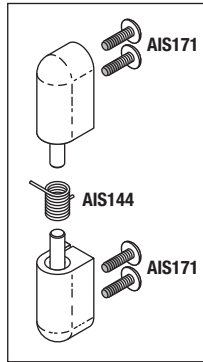

RPI Part #AIH143
OEM Part #MU08163 (Pivot Hinge Only),
68 510 05 (Pivot Hinge Only) &
83 300 08 (Pivot Hinge Only)



PIVOT HINGE (ACCESS DOOR)

- Includes all parts as shown
- Fits:** Hood Assembly
- Models:** C2000, C-100QT, C-200QT, C-400QT, C-450QT, C-500QT, C-500QT model XL, C-550QT & C-550QT model XL

RPI Part #AIS144
OEM Part #MU08164 & 68 510 10



SPRING (TORSION)

- Material: Stainless steel
- .270" OD x .360" lg. x .030" dia. wire
- Also Included in: Pivot Hinge (Access Door) (RPI Part #AIH143)
- Fits:** Access Door Pivot Hinge
- Models:** C2000, C-100QT, C-200QT, C-400QT, C-450QT, C-500QT, C-500QT model XL, C-550QT & C-550QT model XL



RPI Part #AIS171
OEM Part #MU15131 & 99 023 64



SCREW (#6-32 x 7/16)

- 4 per package
- Material: Stainless steel supplied with pre-applied thread locker
- Size: #6-32 x 7/16" lg.
- Also included in: Pivot Hinge (Access Door) (RPI Part #AIH143)
- Models:** C2000, C-100QT, C-200QT, C-400QT, C-450QT, C-500QT, C-500QT model XL, C-550QT & C-550QT model XL

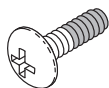

RPI Part #AIS172
OEM Part #MU15142 & 99 024 19



SCREW (#6-32 x 9/16)

- 2 per package
- Material: Stainless steel supplied with pre-applied thread locker
- Size: #6-32 x 9/16" lg.
- Also included in: Latch Kit (Access Door) (RPI Part #AIK161), Keeper (Access Pnl Latch) (RPI Part #AIK162) and Cable Clamp Kit (RPI Part #AIK163)
- Model:** C2000

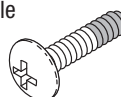

RPI Part #AIG020
OEM Part #MU12609 & 83 200 20



ACCESS GROMMET

- Material: Translucent thermoplastic rubber
- Fits:** Hood Assembly
- Models:** C2000, C-100, C-100QT, C-200, C-200QT, C-300, C-400QT, C-450QT, C-500QT, C-500QT model XL, C-550QT & C-550QT model XL

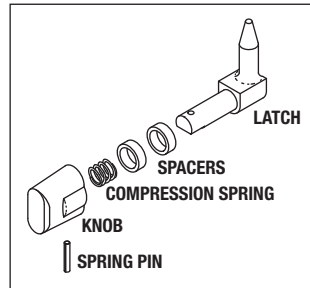
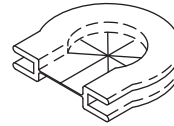

RPI Part #AIK160
OEM Part #MU08534 & 68 902 96



PAWL LATCH KIT

- Includes all parts as shown
- Fits:** Hood Assembly
- Models:** C2000, C-86, C-100, C-100QT, C-200, C-200QT, C-400QT, C-450QT, C-500QT, C-500QT model XL, C-550QT & C-550QT model XL

RPI Part #AIK161
OEM Part #MU13393 & 83 900 09



LATCH KIT (ACCESS DOOR)

- Includes all parts as shown
- Fits:** Hood Assembly
- Model:** C2000

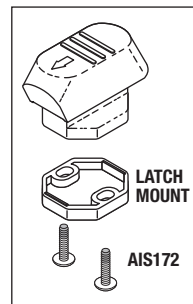

RPI Part #AIK162
OEM Part #MU12604 (Keeper Only) &
83 200 15 (Keeper Only)



KEEPER (ACCESS PNL LATCH)

- Includes all parts as shown
- Fits:** Hood Assembly
- Model:** C2000

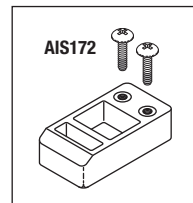

RPI Part #AIK163
OEM Part #MU11061 (Nylon Cable Clamp Only) &
81 020 20 (Nylon Cable Clamp Only)

CABLE CLAMP KIT

- Material: White Nylon® clamp
- Includes all parts as shown
- Fits:** Hood Assembly
- Model:** C2000

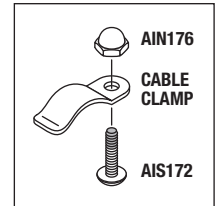

RPI Part #AIN176
OEM Part #MU15421 &
99 105 20



ACORN NUT (#6-32)

- 4 per package
- Material: Stainless steel
- Also included in: Cable Clamp Kit (RPI Part #AIK163)
- Model:** C2000



RPI Part #AIS174
OEM Part #MU15248 &
99 042 66



SCREW (#10-32 x 5/8)

- 2 per package
- Material: Stainless steel supplied with pre-applied thread locker
- Size: #10-32 x 5/8" lg.
- Also included in: Hinge (Access Panel) Front Right (RPI Part #AIH146), Hinge (Access Panel) Front Left (RPI Part #AIH147), Hinge (Access Panel) Rear Right (RPI Part #AIH148), Hinge (Access Panel) Rear Left (RPI Part #AIH149)
- Model:** C2000

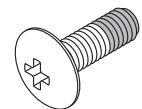

RPI Part #AIS175
OEM Part #MU15254 &
99 042 92



SCREW (#10-32 x 3/4)

- 2 per package
- Material: Stainless steel supplied with pre-applied thread locker
- Size: #10-32 x 3/4" lg.
- Also included in: Hinge (Hood) Front Right (RPI Part #AIH150), Hinge (Hood) Front Left (RPI Part #AIH151), Hinge (Hood) Rear Right (RPI Part #AIH152), Hinge (Hood) Rear Left (RPI Part #AIH153)
- Model:** C2000

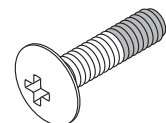

Infant Incubators

Model: Isolette® C2000



RPI Part #AIA154
OEM Part #MU12626 (Slide Only) & 83 200 45 (Slide Only)



SLIDE ASSY (SENSOR MODULE)

- Includes all parts as shown
- Fits:** Hood Assembly
- Model:** C2000

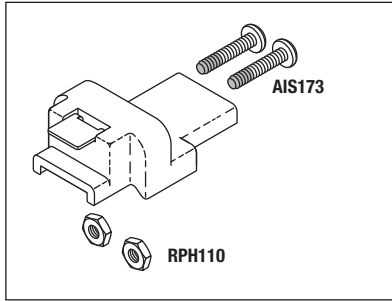

RPI Part #AIS173
OEM Part #MU15147 & 99 024 52



SCREW (#6-32 x 5/8)

- 2 per package
- Material: Stainless steel supplied with pre-applied thread locker
- Size: #6-32 x 5/8" lg.
- Also included in: Slide Assy (Sensor Module) (RPI Part #AIA154)
- Model:** C2000

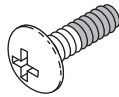

RPI Part #RPH110
OEM Part # (No OEM Part # Available)



HEX NUT (#6-32)

- 50 per package
- Material: Stainless steel
- Size: #6-32 Hex Nut
- Also included in: Hardware Kit (RPI Part #RPK402) and Slide Assy (Sensor Module) (RPI Part #AIA154)
- Model:** C2000



RPI Part #AIK164
OEM Part #MU07138 (Motor Mount Only) & 68 230 24 (Motor Mount Only)



MOTOR MOUNT KIT

- 4 per package
- Material: Rubber vibration mount, stainless steel hardware
- Includes all parts as shown

Fits: Chassis

Model: C2000

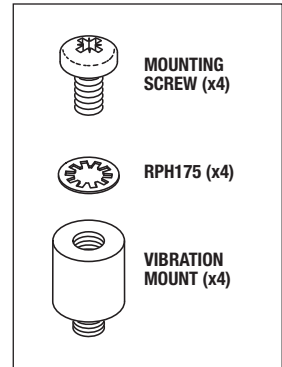

RPI Part #AIL145
OEM Part #MU12681 (Latch Only) & 83 300 09 (Latch Only)



LATCH (HEAT SHIELD)

- Includes all parts as shown
- Fits:** Hood Assembly
- Models:** C2000 & Versalet® 7700

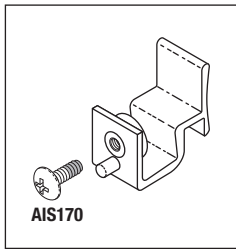

RPI Part #AIS170
OEM Part #MU15127 & 99 023 51



SCREW (#6-32 x 3/8)

- 2 per package
- Material: Stainless steel supplied with pre-applied thread locker
- Size: #6-32 x 3/8" lg.
- Also included in: Latch (Heat Shield) (RPI Part #AIL145)
- Models:** C2000 & Versalet® 7700

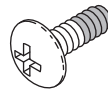

RPI Part #RPH175
OEM Part #MU15553 & 99 122 924



NO. 8 INTERNAL TOOTH WASHER

- 50 per package
- Size: #8
- Material: Stainless steel
- Also included in: Lockwasher Kit (RPI Part #RPK413) and Motor Mount Kit (RPI Part #AIK164)
- Model:** C2000



RPI Part #AIC155
OEM Part #MU13058 & 83 600 30



SCALE CABLE ASSEMBLY

- Length: ~39.5"
- Fits:** Weight Scale
- Model:** C2000

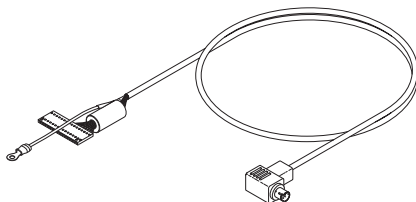

RPI Part #AIC142
OEM Part #MU12564 & 83 110 15



TUBING CAP

- 4 per package
- Material: White plastic
- Size: 1.00" OD
- Fits:** Mattress Tray Lift Bars
- Model:** C2000

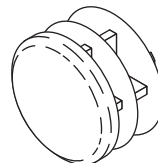

RPI Part #AIS168
OEM Part #MU15296 (1 Pc only) & 99 055 96 (1 Pc only)



SCREW (1/4-20 x 1/2)

- 12 per package
- Material: Stainless steel supplied with pre-applied thread locker
- Size: 1/4-20 x 1/2" lg.
- Fits:** Chassis
- Model:** C2000

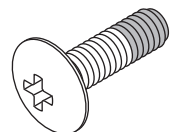

replacement parts industries, inc.

CALL (800) 221-9723 • FAX (818) 882-7028 • EMAIL order@rpiparts.com • WEBSITE www.rpiparts.com