

## GENERAL SHOP AIDS

### ACCESSORIES & SUPPLIES

Adhesives .....	201
Compressor Oil .....	201
Grease .....	201
Hydraulic Fluid .....	201
Lubricants .....	201
Rotary Pump Oil .....	201
Storage Cases .....	200
Threadlocker .....	201

### ELECTRICAL

Cable Ties .....	307
Cable Tie Accessories .....	307
Cable Tie Tool .....	307
Electrical Tape .....	308
Fuses and Fuse Puller .....	306
Heat Shrink Tubing .....	308
High Temperature Sleeving .....	308
High Temperature Terminals and Crimping Tool .....	309
High Temperature Wire .....	309
Hospital Grade Extension Cords .....	302
Hospital Grade Plugs and Connectors .....	304
Hospital Grade Power Cords .....	300-301
Industrial Grade Extension Cords .....	303
Industrial Grade Plugs and Connectors .....	304
Industrial Grade Power Cords .....	302-303
Outlet Module .....	300
Power Cord Accessories .....	303
Receptacles .....	303
Strain Relief Bushings and Strain Relief Pliers .....	305
Terminals and Crimp Tool .....	310

### HARDWARE

Accessories .....	400
L-Hex Wrench Sets .....	400
Lockwasher Kit .....	402
Metric Screws .....	401
Phillips Pan Head Hardware Kit .....	402
Pozidrive® Screwdrivers .....	401
Socket Head Cap Screws .....	400
Socket Head Set Screws .....	400

### O-RINGS

O-Ring Accessories .....	503
O-Ring Kits .....	503-504
O-Ring References .....	500-502
O-Ring Tools .....	503

### PLUMBING

Accessories .....	600-601
Barbs .....	602
Compression Fittings .....	601
Copper Tubing .....	600
Metal Tubing Tools .....	600
Sleeve Tools .....	602

(continued)

## GENERAL SHOP AIDS (continued)

### TOOLS

Adjustment Tool (Spring Tension) .....	702
Balldrivers .....	701
Cable Tie Tool .....	700
Cam Tool .....	701
Fuse Puller .....	700
Gas Spring Tool .....	702
L-Hex Wrench Sets .....	700
Max Register Thermometer .....	701
Metal Tubing Snake and Accessories .....	703
Metal Tubing Tools .....	700
O-Ring Tools .....	702
Plastic Tubing Snake and Accessories .....	703
Pozidrive® Screwdrivers .....	701
Sleeve Tools .....	702
Socket Retractor Tool .....	702
Spanner Wrench and Nuts .....	701
Strain Relief Bushing Pliers .....	700
Terminal Crimp Tool .....	700
Test Pressure Gauge .....	701
Trim Pot Adjustment Tool .....	701
Valve Core Removal Syringe Tool .....	702
Valve Seat Tools .....	701



### RPI Part #RPB560

#### 6-COMPARTMENT STORAGE CASE

- 4" X 8" x 1-3/16"
- Material: Clear plastic

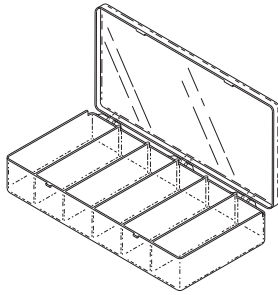

### RPI Part #RPB414

#### 8-COMPARTMENT STORAGE CASE

- 3" x 4-5/8" x 1-1/8"
- Material: Clear plastic

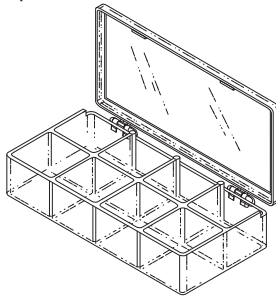

### RPI Part #RPB416

#### 12-COMPARTMENT STORAGE CASE

- 3-3/4" x 7" x 1-1/4"
- Material: Clear plastic

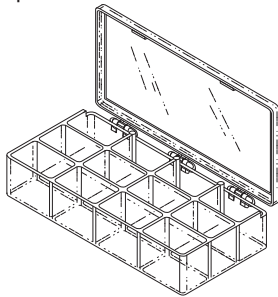

### RPI Part #RPB415

#### 12-COMPARTMENT STORAGE CASE

- 4-1/2" x 8-1/4" x 1-3/8"
- Material: Clear plastic

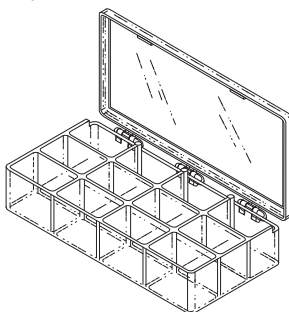

### RPI Part #RPB417

#### 18-COMPARTMENT STORAGE CASE

- 4" x 8" x 1-3/16"
- Material: Clear plastic

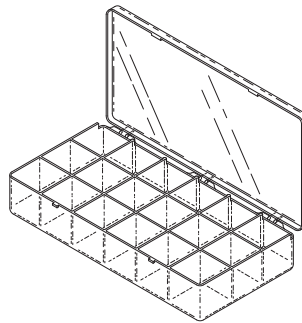

### RPI Part #RPB419

#### 18-COMPARTMENT STORAGE CASE

- 6-3/16" x 10-1/2" x 1-9/16"
- Material: Clear plastic

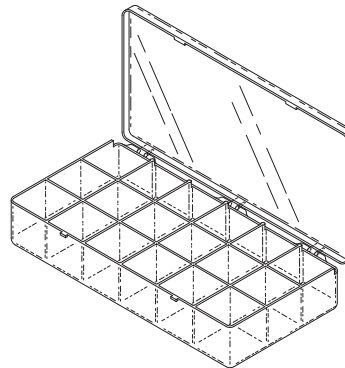

### RPI Part #RPC476

#### CARRYING CASE

- Material: Black plastic case with foam inserts (*The "pick-n-pluck" foam inserts can be customized by you to create your own storage design and a blank case label is included for custom description to fit your needs.*)
- Inside dimensions: 13.25" x 7.38" x 3"
- Outside dimensions: 14" x 10.50" x 3.38"



### RPI Part #RPC753

#### STORAGE CASE

- (3) standard compartments with (10) removable dividers allowing a maximum of 13 compartments
- Size: 12" x 4.5" x 1.5"
- Material: Translucent polypropylene

ADJUSTABLE AND REMOVABLE DIVIDER (x10)

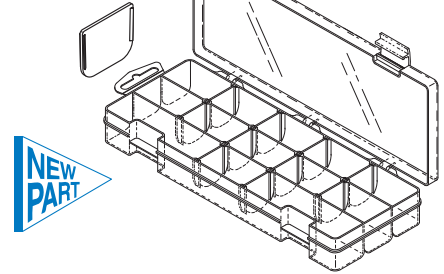

### RPI Part #RPC751

#### STORAGE CASE

- (6) standard compartments with (28) removable dividers allowing a maximum of 34 compartments
- Size: 16.5" x 9.0" x 1.5"
- Material: Translucent polypropylene

ADJUSTABLE AND REMOVABLE DIVIDER (x28)

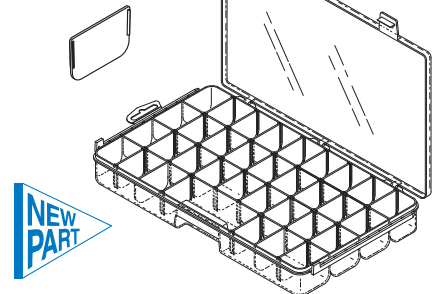

### RPI Part #RPC616

#### STORAGE CASE

- (6) standard compartments (1-11/16" x 6-3/16") with (10) adjustable dividers
- 10-1/2" x 6-3/16" x 1-9/16"
- Material: Translucent polypropylene

ADJUSTABLE AND REMOVABLE DIVIDER (x10)

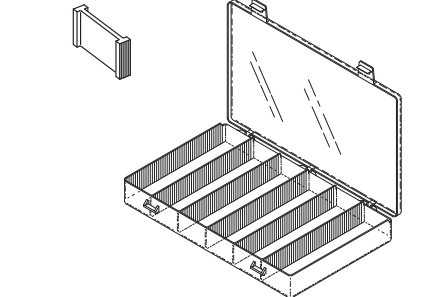

# General Shop Aids

Accessories & Supplies (Adhesives, Compressor Oil, Grease, Hydraulic Fluid, Lubricants, Rotary Pump Oil, and Sealing Tape)

**RPI Part #RPA032  
THREADLOCKER 242**

- 5 per package
- .02 fl. oz. per unit
- Prevents rust and corrosion
- Removable adhesive by Loctite®
- MSDS and Technical Data sheet available on RPI website



**RPI Part #RPA369  
THREADLOCKER 545**

- 5 per package
- .02 fl. oz. per unit
- Temperature range of -65° to +300°F (-54° to +149°C)
- Seals operating pressures up to 10,000 PSI
- For use on all pneumatic and hydraulic fittings
- MSDS and Technical Data sheet available on RPI website



**RPI Part #RPL090  
HIGH TEMP LUBRICANT**

- 5 per package
- 1/2 gram per unit
- For non-silicone use only
- Temperature range: -40° to +400°F (-40° to +204°C)
- MSDS and Technical Data sheet available on RPI website



**RPI Part #RPL615  
O-RING LUBRICANT**

- 2 oz. tube
- Temperature Range: -65° to 400° F
- Can be used on Silicone and non-Silicone rubber materials
- Non-Toxic; Super-O-Lube® made by Parker
- MSDS and Technical Data sheet available on RPI website



**RPI Part #RPC464  
HEAT SINK COMPOUND**

- 5 per package
- .07 fl. oz. (2ml) per unit
- Non-silicone based thermal grease
- Does not dry out
- MSDS and Technical Data sheet available on RPI website



**RPI Part #RPL717  
GREASE**

- 30cc package
- Renolit G 193 Grease
- Amber colored motor gear grease
- Temperature Range: 10° to 400°F
- MSDS and Technical Data sheet available on RPI website



**RPI Part #RPL680  
BEARING GREASE**

- 5 per package
- 0.068 fl. oz. per unit
- Mobilith SHC100; Red synthetic grease
- Temperature Range: -65°F to 350°F (-54°C to 177°C)
- MSDS and Technical Data sheet available on RPI website



**RPI Part #RPS639  
SILICONE GASKET MAKER 598**

- .5 fl. oz.
- Material: RTV black silicone
- Provides a sealant for pump tubing connections or can be used to seal power switch connections
- MSDS and Technical Data sheet available on RPI website

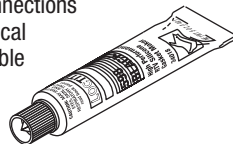

**RPI Part #RPA459  
PIPE SEALANT 567**

- .20 fl. oz. (6ml)
- Temperature range: -65° to +400°F (-54° to +204°C)
- MSDS and Technical Data sheet available on RPI website

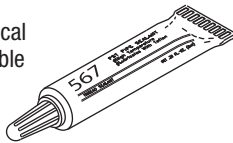

**RPI Part #RPT579  
1/4" TEFLON THREAD SEALING TAPE**

- 5 per package
- 1/4" x 260" per unit

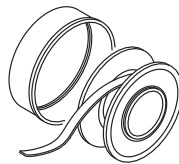

**RPI Part #RPT580  
1/2" TEFLON THREAD SEALING TAPE**

- 5 per package
- 1/2" x 260" per unit



**RPI Part #CML001  
COMPRESSOR OIL**

- 16 fl. oz.
- ISO100
- Non-detergent
- Includes dispensing tube and yorcker cap
- For use with most Copeland® head compressors
- Also available by the case of (12) 16 oz. bottles (RPI Part #CML045)
- MSDS and Technical Data sheet available on RPI website

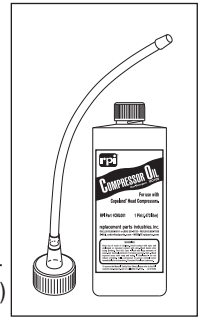

**RPI Part #RPF449  
HYDRAULIC FLUID**

- 16 fl. oz.
- ISO46
- Includes yorcker spout
- For use with most dental chairs
- Also available by the case of (12) 16 oz. bottles (RPI Part #RPF453)
- MSDS and Technical Data sheet available on RPI website

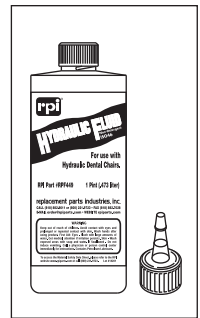

**RPI Part #RPF384  
HYDRAULIC FLUID**

- 32 fl. oz.
- ISO22
- Additive-free 100N mineral oil
- Includes yorcker spout
- For use hydraulic exam tables that use additive free mineral oil
- MSDS and Technical Data sheet available on RPI website



**RPI Part #GOL022  
ROTARY PUMP OIL**

- 4 fl. oz.
- ISO68
- Includes yorcker spout
- For use with Rotary Pumps (dispenses in oil reservoir)
- MSDS and Technical Data sheet available on RPI website

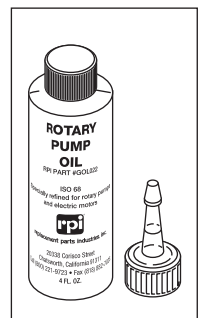

## PowerMATE® - The only UL approved pole-mountable power tap for use in Patient Care areas!

RPI Part #RPP474

### PowerMATE®

- Certified to UL Standard 1363A - for use in patient care areas.
- The 15 ft. power cord increases the mobility of the devices connected to the unit and helps eliminate extra power cord clutter.
- Three dual, hospital grade receptacles mounted in an angled surface allows for multiple AC adapters.
- Features a green power-on indicator on the surface of the unit.
- Unit and plugged in devices are protected by a 15-amp circuit breaker.
- The outlet module mounts on a pole (up to 1.5" in diameter), cart, or mobile flat surface. For indoor use only.
- Features a drip guard for mounting on an IV pole.

- A special nut on the thumbscrew can be tightened to lock the unit onto a pole, or an included locking screw cap can be used to secure the unit on a flat surface to prevent it from being easily moved.



### Eliminate Cord Clutter – Mount unit on a pole or mobile flat surface!



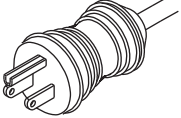
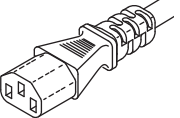
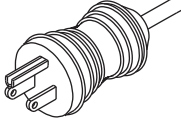
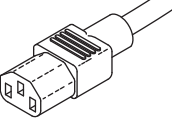
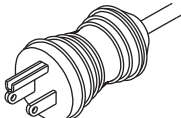
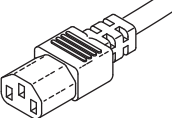
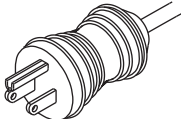
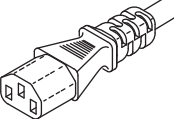
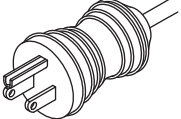
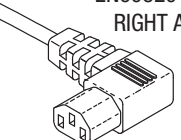

<p><b>POLE MOUNT</b></p> <p><i>Simply slide unit onto IV pole or the leg of a cart. Turn unit's thumbscrew to secure. Tighten locking hex nut.</i></p> 	<p><b>MOBILE FLAT SURFACE MOUNT</b></p> <p><i>Simply drill holes in mobile flat surface. Install mounting screws. Align unit's keyholes with mounting screws to secure. Install Hinged Screw Cover and snap it closed.</i></p> 
------------------------------------------------------------------------------------------------------------------------------------------------------------------------------------------------------------------------------------------	--------------------------------------------------------------------------------------------------------------------------------------------------------------------------------------------------------------------------------------------------------------------------------------------------------------------

HOSPITAL GRADE	RPI PART #	LENGTH	DESCRIPTION	PLUG TYPE	CONNECTOR TYPE	COLOR / GRADE
	RPC260	10 ft.	<b>HOSPITAL GRADE POWER CORD</b> 14/3 SJT, 105°C 15A@125VAC	NEMA 5-15P 	EN60320-C13 	GRAY  HOSPITAL GRADE
	RPC554	8 ft.	<b>HOSPITAL GRADE POWER CORD</b> 14/3 SJT, 105°C 15A@125VAC	NEMA 5-15P 	EN60320-C13 	GRAY  HOSPITAL GRADE
	RPC555	18 ft.	<b>HOSPITAL GRADE POWER CORD</b> 14/3 SJT, 60°C 15A@125VAC	NEMA 5-15P 	EN60320-C13 	GRAY  HOSPITAL GRADE
	RPC556	25 ft.	<b>HOSPITAL GRADE POWER CORD</b> 14/3 SJT, 105°C 15A@125VAC	NEMA 5-15P 	EN60320-C13 	GRAY  HOSPITAL GRADE
	RPC770 RPC772 RPC774	8 ft. 18 ft. 25 ft.	<b>HOSPITAL GRADE POWER CORD</b> 14/3 SJT, 105°C 15A@125VAC	NEMA 5-15P 	EN60320-C13R RIGHT ANGLE 	GRAY  HOSPITAL GRADE

More Hospital Grade Power Cords on next page →

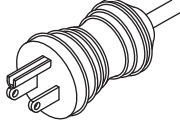
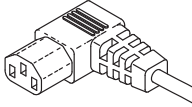
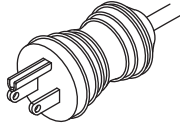
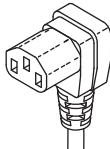
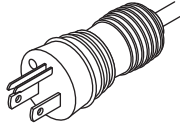
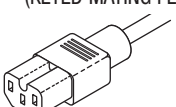
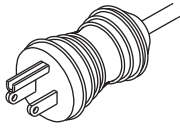
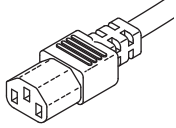
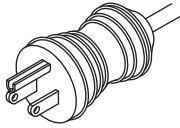
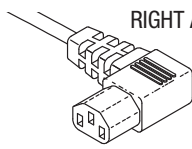
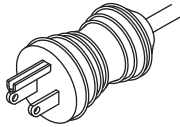
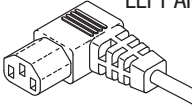
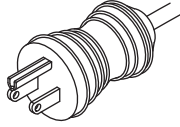
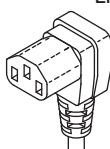
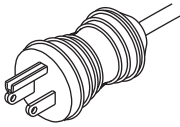
# General Shop Aids

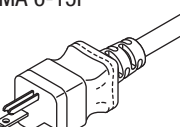
Electrical (Power Cords) - Continued

RPI PART #	LENGTH	DESCRIPTION	PLUG TYPE	CONNECTOR TYPE	COLOR / GRADE
RPC771 RPC773 RPC775	8 ft. 18 ft. 25 ft.	<b>HOSPITAL GRADE POWER CORD</b> 14/3 SJT, 105°C 15A@125VAC	NEMA 5-15P 	EN60320-C13L LEFT ANGLE 	GRAY  HOSPITAL GRADE
RPC776	8 ft.	<b>HOSPITAL GRADE POWER CORD</b> 14/3 SJT, 105°C 15A@125VAC	NEMA 5-15P 	EN60320-C13D DOWN ANGLE 	GRAY  HOSPITAL GRADE
CHC008	8 ft.	<b>HOSPITAL GRADE POWER CORD</b> 14/3 SJTOW, 105°C 15A@125VAC	NEMA 5-15P 	EN60320-C15 (KEYED MATING FEATURE) 	BLACK  HOSPITAL GRADE
RPC868 RPC869 RPC557 RPC558 RPC559	1.5 ft. 3 ft. 8 ft. 18 ft. 25 ft.	<b>HOSPITAL GRADE POWER CORD</b> 16/3 SJT, 60°C 13A@125VAC	NEMA 5-15P 	EN60320-C13 	GRAY  HOSPITAL GRADE
RPC778 RPC780 RPC782 RPC784 RPC786	1.5 ft. 3 ft. 8 ft. 18 ft. 25 ft.	<b>HOSPITAL GRADE POWER CORD</b> 16/3 SJT, 105°C 13A@125VAC	NEMA 5-15P 	EN60320-C13R RIGHT ANGLE 	GRAY  HOSPITAL GRADE
RPC779 RPC781 RPC783 RPC785 RPC787	1.5 ft. 3 ft. 8 ft. 18 ft. 25 ft.	<b>HOSPITAL GRADE POWER CORD</b> 16/3 SJT, 105°C 13A@125VAC	NEMA 5-15P 	EN60320-C13L LEFT ANGLE 	GRAY  HOSPITAL GRADE
RPC788	8 ft.	<b>HOSPITAL GRADE POWER CORD</b> 16/3 SJT, 105°C 13A@125VAC	NEMA 5-15P 	EN60320-C13D DOWN ANGLE 	GRAY  HOSPITAL GRADE
RPC028	10 ft.	<b>HOSPITAL GRADE POWER CORD</b> 18/3 SJT, 60°C 10A@125VAC	NEMA 5-15P 	NONE  .320" OD CORD	GRAY  HOSPITAL GRADE
RPC867	8 ft.	<b>HOSPITAL GRADE POWER CORD</b> 18/3 SJT, 60°C 10A@220VAC	NEMA 6-15P 	NONE  .307" OD CORD	GRAY  HOSPITAL GRADE

HOSPITAL GRADE



Hospital Grade Extension Cords on next page →

### HOSPITAL GRADE

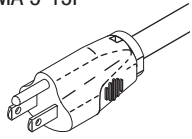
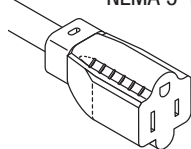
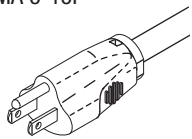
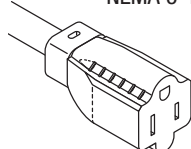
RPI PART #	LENGTH	DESCRIPTION	PLUG TYPE	CONNECTOR TYPE	COLOR / GRADE
<b>RPC870</b> <b>RPC871</b>	8 ft. 12 ft.	<b>HOSPITAL GRADE EXT CORD</b> 16/3 SJT, 60°C 13A@125VAC	NEMA 5-15P 	NEMA 5-15R 	GRAY  HOSPITAL GRADE
<b>RPC872</b> <b>RPC873</b>	8 ft. 12 ft.	<b>HOSPITAL GRADE EXT CORD</b> 14/3 SJT, 60°C 15A@125VAC	NEMA 5-15P 	NEMA 5-15R 	GRAY  HOSPITAL GRADE

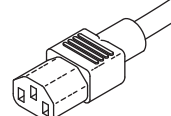
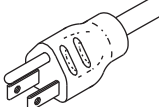
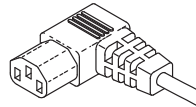
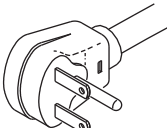
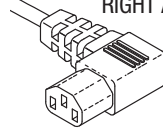
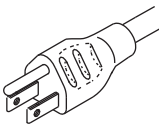
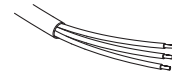
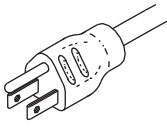
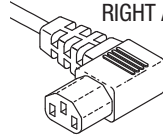
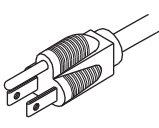
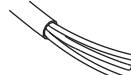
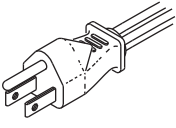
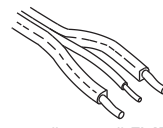

### INDUSTRIAL GRADE

<b>RPC262</b>	10 ft.	<b>POWER CORD</b> 14/3 SJT, 60°C 15A@125VAC	NEMA 5-15P 	EN60320-C13 	BLACK  INDUSTRIAL GRADE
<b>RPC291</b>	6 ft.	<b>POWER CORD</b> 14/3 SJT, 105°C 15A@125VAC	NEMA 5-15P 	EN60320-C13L LEFT ANGLE 	BLACK  INDUSTRIAL GRADE
<b>RPC582</b>	12 ft.	<b>POWER CORD</b> 14/3 SJT, 105°C 15A@220VAC	NEMA 6-15P 	EN60320-C13R RIGHT ANGLE 	BLACK  INDUSTRIAL GRADE
<b>RPC880</b>	9 ft.	<b>POWER CORD</b> 14/3 SJT, 105°C 15A@125VAC	NEMA 5-15P 	NONE   .378" OD CORD	BLACK  INDUSTRIAL GRADE
<b>TUC028</b>	10 ft.	<b>POWER CORD</b> 14/3 SJT, 105°C 15A@125VAC	NEMA 5-15P 	EN60320-C13R RIGHT ANGLE 	BLACK  INDUSTRIAL GRADE
<b>PCC004</b>	8 ft.	<b>POWER CORD</b> 16/3 HSJO, 105°C 13A@125VAC	NEMA 5-15P 	NONE   .350" OD CORD	BLACK  INDUSTRIAL GRADE
<b>RPC274</b>	6 ft.	<b>POWER CORD</b> 16/3 SPT-2, 105°C 13A@125VAC	NEMA 5-15P 	NONE   .158" x .380" FLAT CORD	BLACK  INDUSTRIAL GRADE

More Industrial Grade Power Cords on next page →

General Shop Aids

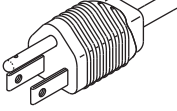
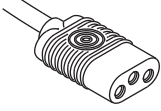
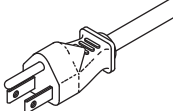
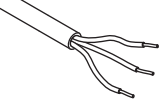
Electrical (Power Cords) - Continued

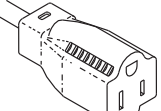
RPI PART #	LENGTH	DESCRIPTION	PLUG TYPE	CONNECTOR TYPE	COLOR / GRADE
BUC017	8 ft.	<b>POWER CORD</b> 18/3 SJT, 60°C 7A@125VAC	NEMA 5-15P 	BMI-3 	GRAY  INDUSTRIAL GRADE
CAC015	8 ft.	<b>POWER CORD</b> 18/3 SJTW, 105°C 10A@125VAC	NEMA 5-15P 	NONE  .328" OD CORD 	BLACK  INDUSTRIAL GRADE
BUC018	8 ft.	<b>EXT CORD</b> 16/3 SJT, 60°C 13A@125VAC	NEMA 5-15P 	NEMA 5-15R 	BLACK  INDUSTRIAL GRADE

**Extension Cord**

INDUSTRIAL GRADE

Electrical (Accessories & Receptacles)

**ACCESSORIES**

**RPI Part #RPS672**  
**CORD STRAP (WHITE 6")**

- 3 per package
- 6" lg.
- White strap with white button
- Use to strap power cords

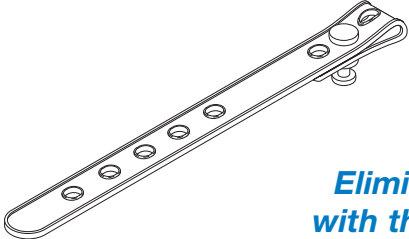

*Eliminate power cord clutter with the adjustable Cord Strap!*

**RECEPTACLES**

**RPI Part #RPR290**  
**SNAP-IN AC RECEPTACLE**

- 15A@250VAC
- 1/4" quick connect tabs
- Fits panel cut-out: .787" x 1.083" (20mm x 27.5 mm); .060" (1.5mm) maximum panel Thk.

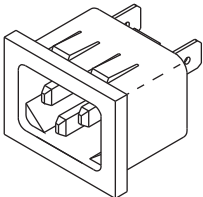

**RPI Part #RPR583**  
**AC INLET RECEPTACLE**

- 15A@250VAC
- 1/4" quick connect tabs
- Fits panel cut-out: .787" x 1.083" (20mm x 27.5 mm); .134" dia. (3.4mm) @ 1.575" (40mm)

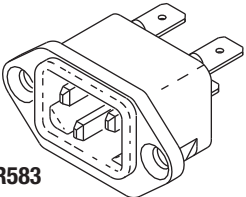

**RPI Part #HBM011**  
**POWER MODULE**

- 15A@250VAC
- 1/4" quick connect tabs
- Fits panel cut-out: .787" x 1.083" (20mm x 27.5 mm); .079" (2mm) maximum panel Thk.

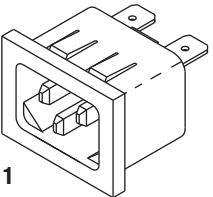

**RPI Part #GEM015**  
**POWER INPUT MODULE**

- Includes installed fuse holders and (2 pcs) 1/2A@250VAC Fuse (RPI Part #RPF043)
- 1/8" quick connect tabs
- Fits panel cut-out: 1.220" x 2.205"

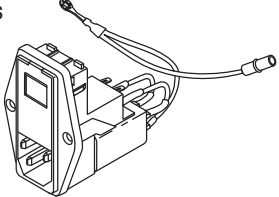

**RPI Part #RPR710**  
**AC INLET RECEPTACLE**

- 15A@125VAC
- 1/4" quick connect tabs
- Keyed mating feature
- Includes: Mounting hardware
- Fits panel cut-out: .787" x 1.083"

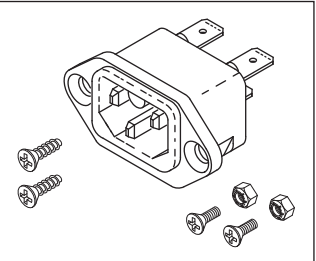



### Hubbell® Brand Plugs and Connectors or Alternate Products - It's Your Choice!

The choice is yours. RPI is pleased to provide you with an option for your plug and connector requirements by offering top-of-the-line Hubbell products, as well as a quality, lower cost alternative for each plug and connector configuration. The alternate products that we offer are manufactured by reputable companies such as Woodhead and Marinco®. It's the RPI Advantage!

*Please note: Illustrations show Hubbell part, alternate product may vary slightly in attributes and appearance.*

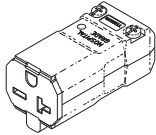
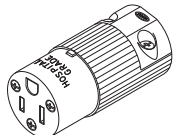
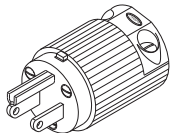
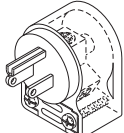
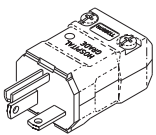
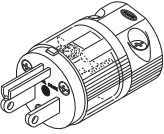
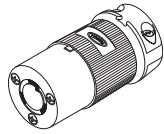
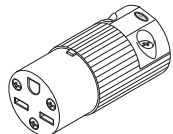
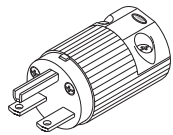
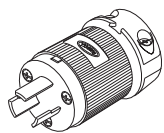
	RPI PART # (MADE BY HUBBELL)	RPI PART # (ALTERNATE PRODUCT)	PLUG/CONNECTOR TYPE
HOSPITAL GRADE	RPC585	RPC591	<b>HOSPITAL GRADE FEMALE CONNECTOR</b> <ul style="list-style-type: none"> <li>• 20A@250VAC</li> <li>• Accepts .300" dia. to .660" dia. cord</li> <li>• NEMA 6-20R</li> </ul> 
	RPC599	RPC031	<b>HOSPITAL GRADE FEMALE CONNECTOR</b> <ul style="list-style-type: none"> <li>• 15A@125VAC</li> <li>• Accepts .325" dia. to .720" dia. cord</li> <li>• NEMA 5-15R</li> </ul> 
	RPP029	RPP596	<b>HOSPITAL GRADE MALE PLUG</b> <ul style="list-style-type: none"> <li>• 15A@125VAC</li> <li>• Accepts .230" dia. to .720" dia. cord</li> <li>• NEMA 5-15P</li> </ul> 
	RPP032	RPP597	<b>HOSPITAL GRADE MALE PLUG (RIGHT ANGLE)</b> <ul style="list-style-type: none"> <li>• 15A@125VAC</li> <li>• Accepts .255" dia. to .665" dia. cord</li> <li>• NEMA 5-15P</li> <li>• Transparent housing</li> </ul> 
	RPP584	RPP590	<b>HOSPITAL GRADE MALE PLUG</b> <ul style="list-style-type: none"> <li>• 20A@250VAC</li> <li>• Accepts .300" dia. to .660" dia. cord</li> <li>• NEMA 6-20P</li> </ul> 
	RPP598	RPP030	<b>HOSPITAL GRADE MALE PLUG</b> <ul style="list-style-type: none"> <li>• 15A@125VAC</li> <li>• Accepts .230" dia. to .720" dia. cord</li> <li>• NEMA 5-15P</li> <li>• Transparent housing</li> </ul> 
INDUSTRIAL GRADE	RPC587	RPC593	<b>FEMALE CONNECTOR (LOCKING)</b> <ul style="list-style-type: none"> <li>• 20A@250VAC</li> <li>• Accepts .360" dia. to .930" dia. cord</li> <li>• NEMA L6-20R</li> </ul> 
	RPC589	RPC595	<b>FEMALE CONNECTOR</b> <ul style="list-style-type: none"> <li>• 15A@250VAC</li> <li>• Accepts .230" dia. to .720" dia. cord</li> <li>• NEMA 6-15R</li> </ul> 
	RPP588	RPP594	<b>MALE PLUG</b> <ul style="list-style-type: none"> <li>• 15A@250VAC</li> <li>• Accepts .230" dia. to .720" dia. cord</li> <li>• NEMA 6-15P</li> </ul> 
	RPP586	RPP592	<b>MALE PLUG (LOCKING)</b> <ul style="list-style-type: none"> <li>• 20A@250VAC</li> <li>• Accepts .360" dia. to .930" dia. cord</li> <li>• NEMA L6-20P</li> </ul> 

# General Shop Aids

Electrical (Strain Relief Bushings, and Strain Relief Bushing Pliers)

RPI Part #RPT172

**STRAIN RELIEF BUSHING PLIERS**

- Hand pliers adjustable for all bushings that assemble into mounting hole up to 7/8" diameter
- ~7" lg.

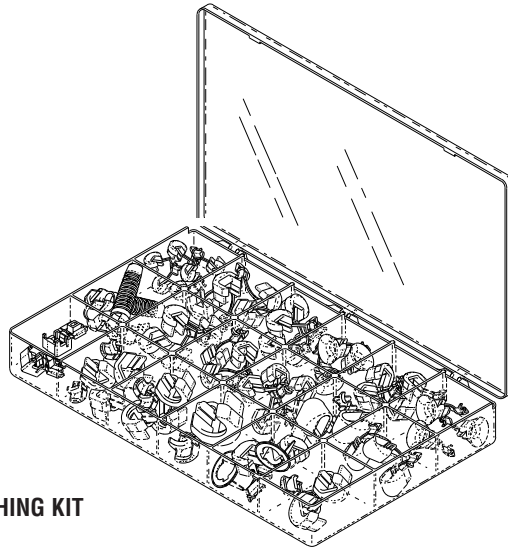
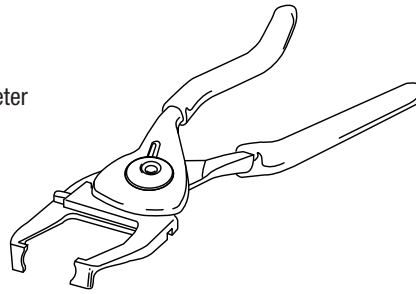

**RPK412  
STRAIN RELIEF BUSHING KIT**

RPI Part #RPK412

**STRAIN RELIEF BUSHING KIT**

- Kit includes 18-compartment storage case (RPI Part #RPB419)
- Strain relief bushings are also sold separately in quantities indicated below

RPI PART #	TYPE	CORD TYPE	CORD OD RANGE	MOUNTING HOLE	QTY
RPB154	SR-3P-4	FLAT CABLE	.120" x .220"	7/16"	20
RPB155	SR-5N-7	ROUND CABLE	.250" - .290"	1/2"	5
RPB156	ST-100N	FLAT CABLE	.120" - .160" x .220" - .300"	1/2"	10
RPB157	SR-4K-6	FLAT CABLE	.120" - .150" x .280" - .300"	1/2"	10
RPB158	SR-5K-4	FLAT CABLE	.150" - .200" x .350" - .410"	9/16"	10
RPB159	SR-7P-2	ROUND CABLE	.360" - .430"	3/4"	6
RPB160	SR-4N-4	FLAT CABLE	.120" - .150" x .280" - .300"	1/2"	15
RPB161	SR-6W-1	ROUND CABLE	.300"	1/2"	15
RPB162	SR-8P-2	ROUND CABLE	.530" - .600"	7/8"	4
RPB163	SR-4N-5	FLAT CABLE	.120" - .160" x .280" - .300"	1/2"	8
RPB164	SR-6N3-4	ROUND CABLE	.325" - .360"	5/8"	8
RPB165	SR-9P-2	ROUND CABLE	.600" - .690"	1"	1
RPB166	SR-5P-4	ROUND CABLE	.250" - .290"	1/2"	15
RPB167	SR-11-2	ROUND CABLE	.325" - .355"	5/8"	6
RPB168	SR-30-1	FLAT CABLE	.150" - .200" x .350" - .430"	9/16"	5
RPB169	SR-5N-5	ROUND CABLE	.250" - .290"	1/2"	8
RPB170	SR-14-1	FLAT CABLE	.120" - .160" x .280" - .300"	1/2"	10
RPB171	SR-34-2	FLAT CABLE	.240" - .290" x .420" - .650"	7/8"	4

 RPB154 & RPB160	 RPB163
 RPB155	 RPB165
 RPB156	 RPB167
 RPB157	
 RPB158, RPB164 & RPB166	 RPB169
 RPB159	 RPB170
 RPB161	 RPB171
 RPB162	<p>Visit the RPI website <a href="http://www.rpiparts.com">www.rpiparts.com</a></p>

### RPI Part #RPT502

#### FUSE PULLER

- ~2" lg.
- Yellow Polycarbonate
- Non-slip handle
- Removes or installs glass, ceramic or blade style fuses
- Ideal for tight spaces

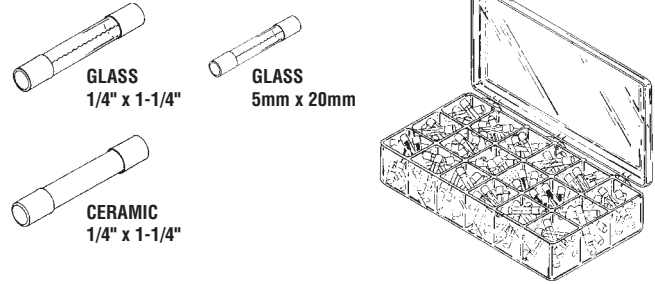
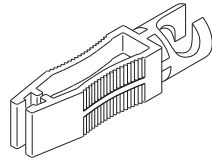

### RPI PART #RPK410

#### FUSE KIT (1/4" x 1-1/4" FAST ACTING)

- Kit includes 18-compartment storage case (RPI Part #RPB417)
- Fuses are also sold separately in quantities indicated below

RPI PART #	AMPS	VOLTS	TYPE	QTY
RPF041	1/8A	250V	GLASS	5
RPF042	1/4A	250V	GLASS	5
RPF043	1/2A	250V	GLASS	5
RPF044	3/4A	250V	GLASS	5
RPF045	1A	250V	GLASS	5
RPF073	1-1/4A	250V	GLASS	5
RPF046	1-1/2A	250V	GLASS	5
RPF047	2A	250V	GLASS	5
RPF048	2-1/2A	250V	GLASS	5
RPF049	3A	250V	GLASS	5
RPF050	4A	250V	GLASS	5
RPF051	5A	250V	GLASS	5
RPF052	6A	250V	GLASS	5
RPF053	8A	250V	GLASS	5
RPF054	10A	250V	GLASS	5
RPF055	15A	32V	GLASS	5
RPF056	25A	32V	GLASS	5
RPF057	30A	32V	GLASS	5

### RPI PART #RPK520

#### FUSE KIT (5mm x 20mm FAST ACTING)

- Kit includes 18-compartment storage case (RPI Part #RPB417)
- Fuses are also sold separately in quantities indicated below

RPI PART #	AMPS	VOLTS	TYPE	QTY
RPF503	1/32A	250V	GLASS	5
RPF504	1/20A	250V	GLASS	5
RPF505	1/10A	250V	GLASS	5
RPF506	1/8A	250V	GLASS	5
RPF507	1/5A	250V	GLASS	5
RPF508	1/4A	250V	GLASS	5
RPF509	2/5A	250V	GLASS	5
RPF510	1/2A	250V	GLASS	5
RPF511	4/5A	250V	GLASS	5
RPF512	1A	250V	GLASS	5
RPF513	1-1/4A	250V	GLASS	5
RPF367	2A	250V	GLASS	5
RPF514	2-1/2A	250V	GLASS	5
RPF515	4A	250V	GLASS	5
RPF516	5A	250V	GLASS	5
RPF517	8A	250V	GLASS	5
RPF518	10A	250V	GLASS	5
RPF519	15A	250V	GLASS	5

### RPI PART #RPK411

#### FUSE KIT (1/4" x 1-1/4" TIME DELAY)

- Kit includes 18-compartment storage case (RPI Part #RPB417)
- Fuses are also sold separately in quantities indicated below

RPI PART #	AMPS	VOLTS	TYPE	QTY
RPF058	1/10A	250V	GLASS	5
RPF059	1/4A	250V	GLASS	5
RPF060	1/2A	250V	GLASS	5
RPF061	1A	250V	GLASS	5
RPF062	1-1/2A	250V	GLASS	5
RPF063	2A	250V	GLASS	5
RPF064	2-1/2A	250V	GLASS	5
RPF065	3A	250V	GLASS	5
RPF066	4A	250V	GLASS	5
RPF067	5A	250V	GLASS	5
RPF068	6-1/4A	250V	GLASS	5
RPF069	15A	32V	GLASS	5
RPF551	6A	250V	CERAMIC	5
RPF552	8A	250V	CERAMIC	5
RPF553	10A	250V	CERAMIC	5
RPF070	12A	250V	CERAMIC	5
RPF071	15A	250V	CERAMIC	5
RPF072	20A	250V	CERAMIC	5

### RPI PART #RPK538

#### FUSE KIT (5mm x 20mm TIME DELAY)

- Kit includes 18-compartment storage case (RPI Part #RPB417)
- Fuses are also sold separately in quantities indicated below

RPI PART #	AMPS	VOLTS	TYPE	QTY
RPF521	1/32A	250V	GLASS	5
RPF522	1/20A	250V	GLASS	5
RPF523	1/10A	250V	GLASS	5
RPF524	1/8A	250V	GLASS	5
RPF525	1/5A	250V	GLASS	5
RPF368	1/4A	250V	GLASS	5
RPF526	2/5A	250V	GLASS	5
RPF527	1/2A	250V	GLASS	5
RPF528	4/5A	250V	GLASS	5
RPF529	1A	250V	GLASS	5
RPF530	1-1/4A	250V	GLASS	5
RPF531	2A	250V	GLASS	5
RPF532	2-1/2A	250V	GLASS	5
RPF533	4A	250V	GLASS	5
RPF534	5A	250V	GLASS	5
RPF535	8A	250V	GLASS	5
RPF536	10A	250V	GLASS	5
RPF537	15A	250V	GLASS	5

# General Shop Aids

Electrical (Cable Ties, Cable Tie Tool, and Accessories)

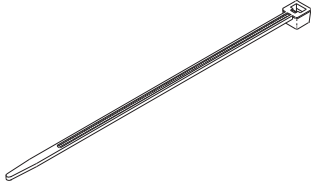

**RPI Part #RPT085**  
**CABLE TIE (8" BLACK)**  
 • 25 per package  
 • 3/16" x 8" lg.

**RPI Part #RPT375**  
**CABLE TIE (12" BLACK)**  
 • 25 per package  
 • 3/16" x 12" lg.



**RPI Part #RPT396**  
**CABLE TIE (4" GRAY)**  
 • 25 per package  
 • .098" x 4" lg.

**RPI Part #RPT397**  
**CABLE TIE (8" GRAY)**  
 • 25 per package  
 • .098" x 8" lg.

**RPI Part #RPT398**  
**CABLE TIE (12" GRAY)**  
 • 25 per package  
 • .145" x 12" lg.

**RPI Part #RPT083**  
**CABLE TIE (4" WHITE)**  
 • 25 per package  
 • 1/8" x 4" lg.

**RPI Part #RPT661**  
**CABLE TIE (6" WHITE)**  
 • 25 per package  
 • 1/8" x 6" lg.



**RPI Part #RPT084**  
**CABLE TIE (8" WHITE)**  
 • 25 per package  
 • 3/16" x 8" lg.

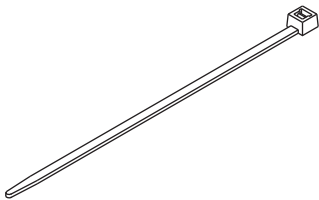

**RPI Part #RPT480**  
**CABLE TIE - HIGH TEMP (4" AQUA BLUE)**  
 • 25 per package  
 • 1/8" x 4" lg.  
 • Material: Tefzel®  
 • Max. temperature rating: 338°F (170°C)  
 • Resistant to most chemicals

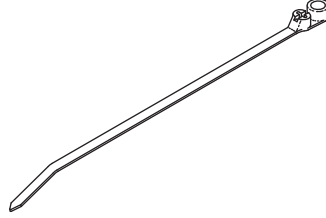

**RPI Part #RPT278**  
**CABLE TIE (8" WHITE)**  
 • 25 per package  
 • 3/16" x 8" lg.  
 • With #10 mounting hole

**RPI Part #RPT279**  
**CABLE TIE (8" BLACK)**  
 • 25 per package  
 • 3/16" x 8" lg.  
 • With #10 mounting hole

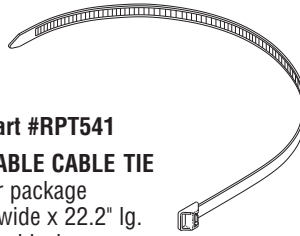

**RPI Part #RPT541**  
**REUSABLE CABLE TIE**  
 • 5 per package  
 • .50" wide x 22.2" lg.  
 • Color: black  
 • Material: Weather resistant Nylon®  
 • Extra heavy duty  
 • Maximum size of bundle is 6.0"  
 • Releasable strap for quick removal  
 • Reusable strap  
 • Can be used to mount Midwest fiber optic light source (OEM Part #491043R)

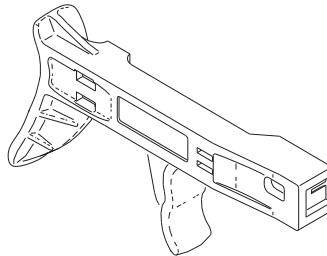

**RPI Part #RPT477**  
**CABLE TIE TOOL**  
 • ~6-1/2" lg.  
 • Material: Plastic  
 • Use this tool for applying a wide variety of ties making for fast application and a clean cut-off  
 • A lightweight pocket sized tool  
 • .094" to .184" tie width  
 • Made by Thomas & Betts



**RPI Part #RPM542**  
**CABLE TIE MOUNT (4-WAY)**  
 • 10 per package  
 • 1" x 1"  
 • Material: Natural Nylon®  
 • Adhesive backed mount  
 • .190" dia. countersunk mounting hole  
 • Allows up to .22" wide cable ties

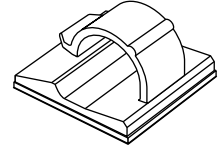

**RPI Part #ADC058**  
**CORD CLIP**  
 • 10 per package  
 • 3/8" wire capacity  
 • Material: Natural Nylon®  
 • Adhesive backing  
 • Meets UL94V-2 Flame Class

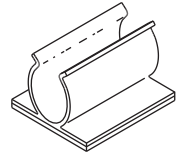

**RPI Part #RPC543**  
**SNAP-IN CORD CLIP**  
 • 10 per package  
 • 1" x 1" with a 1/2" dia. holding capacity  
 • Material: PVC  
 • Color: gray  
 • Adhesive backed mount

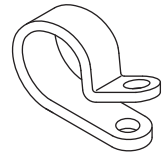

**RPI Part #RPC701**  
**CABLE CLAMP**  
 • 5 per package  
 • For 1/4" OD bundle  
 • Material: Nylon®  
 • #8 mounting hole



**RPI Part #RPC702**  
**CABLE HOLDER**  
 • 5 per package  
 • 3/8" ID  
 • Material: Nylon®  
 • #10 mounting hole  
 • Flexible loop for ease of installing and removing tubing

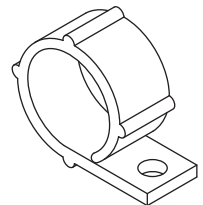

### RPI Part #RPK499

#### HEAT SHRINK TUBING KIT

- 75 pieces of various sizes per Kit
- Each tube ~4" lg.
- Shrink temperature: 158°F (70°C)
- Shrinks to 50% original size
- Color of tubing: Black
- Kit includes 6-compartment storage case (RPI Part #RPB560)
- Tubing is also sold separately in quantities indicated below

RPI PART #	STARTING OD	FINISHED OD	QTY
RPT573	1/8"	1/16"	30
RPT574	3/16"	3/32"	20
RPT575	1/4"	1/8"	10
RPT576	3/8"	3/16"	5
RPT577	1/2"	1/4"	5
RPT578	3/4"	3/8"	5

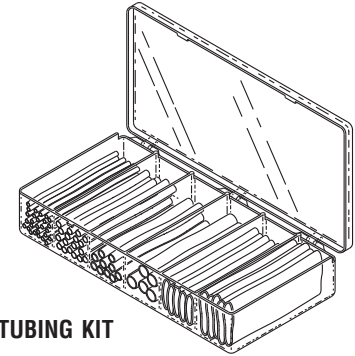

RPK499  
HEAT SHRINK TUBING KIT

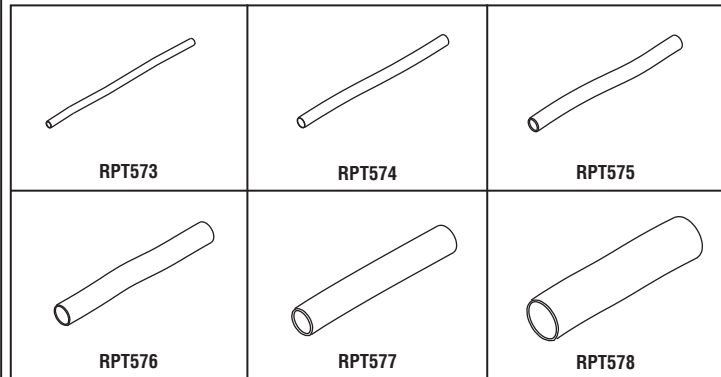

### RPI Part #RPS381

#### HI-TEMP SLEEVING

- Sold by the foot (Reel NOT included)
- 5/32" nom. ID expands to 3/16" max ID
- Silicone rubber coated fiberglass sleeving
- Color: tan
- Temperature rating -67°F to +392°F (-55°C to +200°C)
- High current protection
- Flexible
- Great for protecting non-insulated terminals, butt connectors and all in-line connections

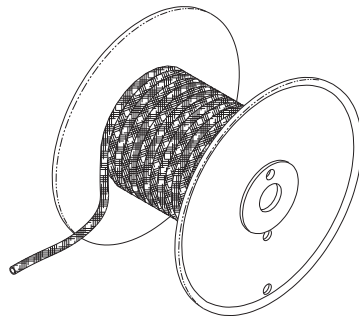

### RPI Part #RPS399

#### HI-TEMP SLEEVING

- Sold by the foot (Reel NOT included)
- 1/4" nom. ID expands to 3/8" max ID
- Silicone rubber coated fiberglass sleeving
- Color: tan
- Temperature rating -67°F to +392°F (-55°C to +200°C)
- High current protection
- Flexible
- Great for protecting non-insulated terminals, butt connectors and all in-line connections

### RPI Part #RPT500

#### ELECTRICAL TAPE

- 3/4" x 66'
- Material: Black vinyl
- 600V dielectric, 220°F (105°C) max temperature
- Waterproof
- UL Listed
- 3M Scotch Super 33+
- Dispenser pack with built-in tape cutter

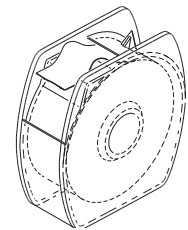

Visit the RPI website  
[www.rpiparts.com](http://www.rpiparts.com)

# General Shop Aids

Electrical (High Temperature Terminals, High Temperature Wire, and Crimping Tool)

**RPI Part #RPT482**

**TERMINAL CRIMP TOOL**

- ~ 8-1/4" lg.
- Steel with cushion grip handles
- Wire stripper - AWG #10 to #22
- Crimps #10 to #22 insulated and non-insulated terminals
- Cuts #4-40 to #10-32 screws
- Hardened pivot joint bushing for long life
- Includes pliers at tip, wire loop former and wire cutter
- Made by Blue Point® for Snap-on®

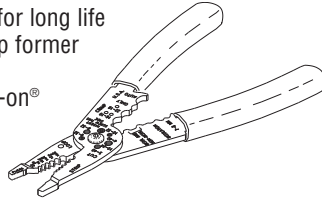



**RPK406  
CRIMP-ON WIRE  
CONNECTOR KIT (HIGH TEMP)**

**RPI PART #RPK406**

**CRIMP-ON WIRE CONNECTOR KIT (HIGH TEMP)**

- Kit includes 12-compartment storage case (RPI Part #RPB416)
- Terminals are also sold separately in quantities indicated below

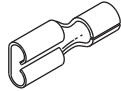
RPI PART #	SIZE	AWG RANGE	QTY
RPT019	#8 RING TERMINAL	#16-14 AWG	20
RPT020	#10 RING TERMINAL	#16-14 AWG	20
RPT021	#8 RING TERMINAL	#12-10 AWG	20
RPT022	#10 RING TERMINAL	#12-10 AWG	20
RPT023	1/4" RING TERMINAL	#12-10 AWG	20
RPT024	5/16" RING TERMINAL	#12-10 AWG	10
RPT025	#10 SPADE TERMINAL	#16-14 AWG	20
RPT026	#10 SPADE TERMINAL	#12-10 AWG	20
RPT027	BUTT CONNECTOR	#16-14 AWG	20
RPT028	BUTT CONNECTOR	#12-10 AWG	20
RPT029	QUICK DISCONNECT .250" FEMALE TAB	#16-14 AWG	20
RPT030	QUICK DISCONNECT .250" MALE TAB	#16-14 AWG	20

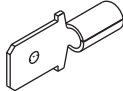
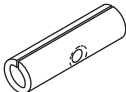
 <b>RING TERMINAL</b>	 <b>QUICK DISCONNECT .250" FEMALE TAB</b>
 <b>SPADE TERMINAL</b>	 <b>QUICK DISCONNECT .250" MALE TAB</b>
 <b>BUTT CONNECTOR</b>	<p>Visit the <b>RPI website</b> <a href="http://www.rpiparts.com">www.rpiparts.com</a></p>

**Wire (High Temperature)**

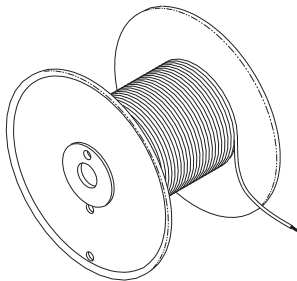

**HIGH TEMPERATURE WIRE**

- Sold by the foot (Reel NOT included)
- Teflon® insulated
- Type EE, 1000V
- Max. operating temperature: 392°F (200°C)

RPI PART #	AWG	COLOR
RPW034	#14 AWG	YELLOW
RPW076	#14 AWG	RED
RPW077	#14 AWG	BLACK
RPW086	#14 AWG	WHITE
RPW033	#16 AWG	WHITE
RPW078	#20 AWG	BLUE
RPW079	#20 AWG	VIOLET
RPW080	#20 AWG	RED
RPW081	#20 AWG	BLACK
RPW082	#20 AWG	ORANGE

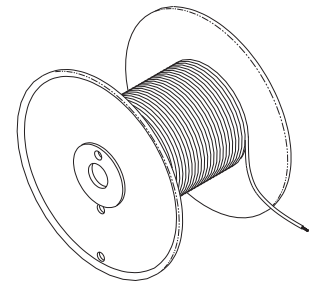

**RPI Part #RPW382**

**HOOK UP WIRE**

- Sold by the foot (Reel NOT included)
- #14 AWG
- Voltage rating: 600V
- Color: black
- Insulation: Chemically cross-linked Polyolefin
- Non-Teflon
- Max. operating temperature: 257°F (125°C)

### RPI Part #RPT482

#### TERMINAL CRIMP TOOL

- ~8-1/4" lg.
- Steel with cushion grip handles
- Wire stripper - AWG #10 to #22
- Crimps #10 to #22 insulated and non-insulated terminals
- Cuts #4-40 to #10-32 screws
- Hardened pivot joint bushing for long life
- Includes pliers at tip, wire loop former and wire cutter
- Made by Blue Point® for Snap-on®

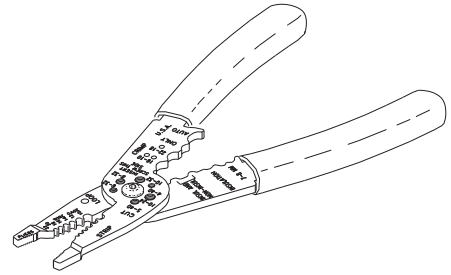

### RPK401 CRIMP-ON WIRE CONNECTOR & WIRE NUT KIT

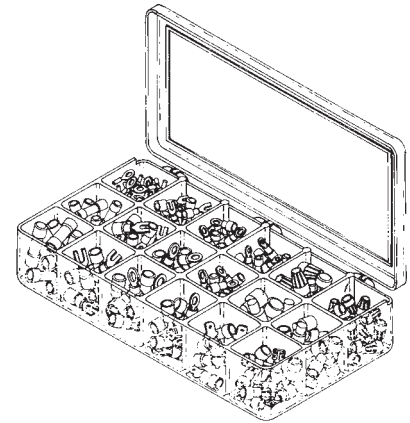

### RPI PART #RPK401

#### CRIMP-ON WIRE CONNECTOR & WIRE NUT KIT

- Kit includes 18-compartment storage case (RPI Part #RPB417)
- Terminals are also sold separately in quantities indicated below

RPI PART #	SIZE	AWG RANGE	STYLE	QTY
RPT001	#6 RING TERMINAL	#22-18 AWG	NON-INSULATED	20
RPT002	#4 RING TERMINAL	#22-18 AWG	INSULATED (RED)	20
RPT003	#6 RING TERMINAL	#22-18 AWG	INSULATED (RED)	20
RPT004	#8 RING TERMINAL	#22-16 AWG	INSULATED (RED)	20
RPT005	#6 RING TERMINAL	#16-14 AWG	INSULATED (BLUE)	20
RPT006	#8 RING TERMINAL	#16-14 AWG	INSULATED (BLUE)	20
RPT007	#10 RING TERMINAL	#16-14 AWG	INSULATED (BLUE)	20
RPT008	#6 SPADE TERMINAL	#16-14 AWG	INSULATED (BLUE)	20
RPT009	#8 SPADE TERMINAL	#16-14 AWG	INSULATED (BLUE)	20
RPT010	#10 SPADE TERMINAL	#16-14 AWG	INSULATED (BLUE)	20
RPT011	BUTT CONNECTOR	#22-18 AWG	INSULATED (RED)	20
RPT012	BUTT CONNECTOR	#16-14 AWG	INSULATED (BLUE)	20
RPT013	PIG TAIL	#16-14 AWG	INSULATED (CLEAR)	20
RPT014	PIG TAIL	#12-10 AWG	INSULATED (CLEAR)	10
RPT015	QUICK DISCONNECT .250" FEMALE TAB	#16-14 AWG	INSULATED (BLUE)	20
RPT016	QUICK DISCONNECT .250" MALE TAB	#16-14 AWG	INSULATED (BLUE)	20
RPT017	WIRE NUT	#22-16 AWG	INSULATED (GREY)	15
RPT018	WIRE NUT	#18-12 AWG	INSULATED (YELLOW)	5

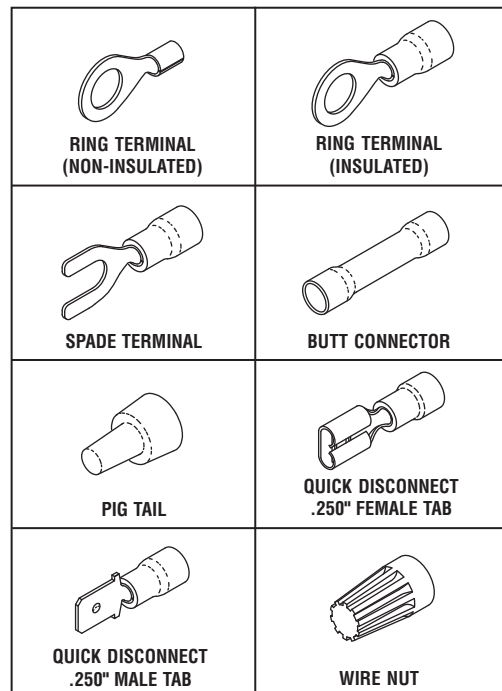

For high temperature wire connector kit and wire, see previous page.





### RPI Part #RPT539

#### L-HEX WRENCH SET (METRIC)

- 9 piece set
- 1.5 mm through 10 mm
- Corrosion protected steel
- Made by Bondhus®

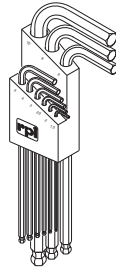

### RPI Part #RPT540

#### L-HEX WRENCH SET (INCH)

- 13 piece set
- .050" through 3/8"
- Corrosion protected steel
- Made by Bondhus®

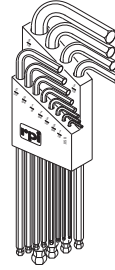

### RPI Part #RPA032

#### THREADLOCKER 242

- 5 per package
- .02 fl. oz. per unit
- Prevents rust and corrosion
- Removable adhesive by Loctite®
- MSDS and Technical Data sheet available on RPI website

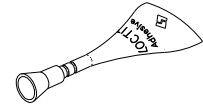

### RPI PART #ADK110

#### SOCKET HEAD CAP SCREW KIT

- Kit includes 12-compartment storage case (RPI Part #RPB416)
- Stainless steel
- Hardware is also sold separately in quantities indicated below

RPI PART #	SIZE	QTY
ADS053	#6-32 x 1/4" lg.	25
ADS111	#6-32 x 3/8" lg.	25
ADS112	#6-32 x 1/2" lg.	25
ADS113	#6-32 x 5/8" lg.	25
ADS114	#6-32 x 7/8" lg.	25
ADS115	#6-32 x 1" lg.	25
ADS116	#4-40 x 1/4" lg.	25
ADS117	#4-40 x 3/8" lg.	25
ADS118	#4-40 x 1/2" lg.	25
ADS119	#4-40 x 3/4" lg.	25
ADS120	#2-56 x 1/2" lg.	25
ADS121	#1/4-20 x 5/8" lg.	15

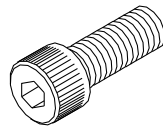

SOCKET HEAD CAP SCREW

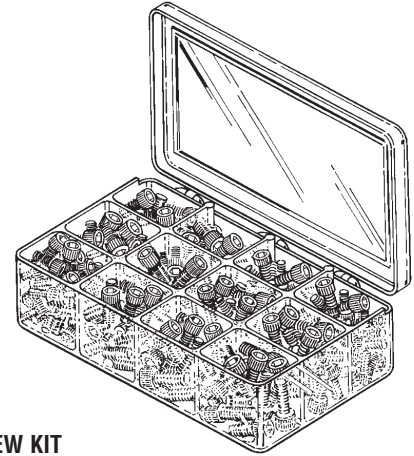

ADK110  
SOCKET HEAD CAP SCREW KIT

### RPI PART #RPK418

#### SOCKET SET SCREW KIT

- Kit includes 18-compartment storage case (RPI Part #RPB417)
- Heat treated alloy steel have black finish
- Cup point
- Hardware is also sold separately in quantities indicated below

RPI PART #	SIZE	QTY
RPH191	#4-40 x 1/8" lg.	50
RPH192	#4-40 x 3/16" lg.	50
RPH193	#4-40 x 1/4" lg.	50
RPH194	#6-32 x 1/8" lg.	50
RPH195	#6-32 x 3/16" lg.	50
RPH196	#6-32 x 1/4" lg.	50
RPH197	#6-32 x 5/16" lg.	50
RPH198	#6-32 x 3/8" lg.	50
RPH199	#8-32 x 1/8" lg.	50
RPH200	#8-32 x 3/16" lg.	50
RPH201	#8-32 x 1/4" lg.	50
RPH202	#8-32 x 5/16" lg.	50
RPH203	#8-32 x 3/8" lg.	50
RPH204	#10-32 x 3/16" lg.	50
RPH205	#10-32 x 1/4" lg.	50
RPH206	#10-32 x 5/16" lg.	50
RPH207	#10-32 x 3/8" lg.	50
RPH208	#10-32 x 1/2" lg.	50

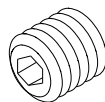

SOCKET SET SCREW CUP POINT

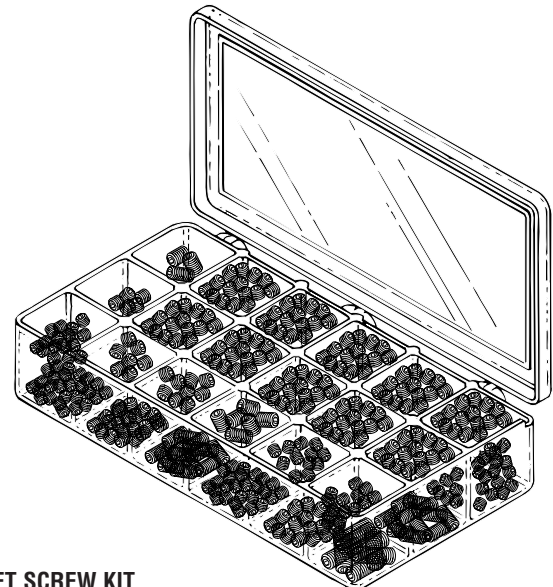

RPK418  
SOCKET SET SCREW KIT

# General Shop Aids

Hardware (Metric Screws, and Pozidrive® Screwdrivers)

**RPT151**

**POZIDRIVE® SCREWDRIVER #1**

- ~6-1/2" lg.
- For use with the Pozidrive Screw Kit (RPI Part #RPK407)

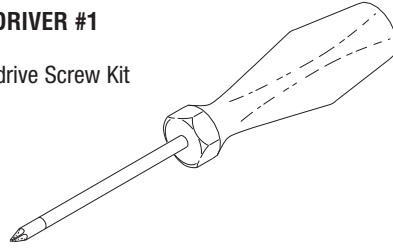

**RPT152**

**POZIDRIVE® SCREWDRIVER #2**

- ~8" lg.
- For use with the Pozidrive Screw Kit (RPI Part #RPK407)

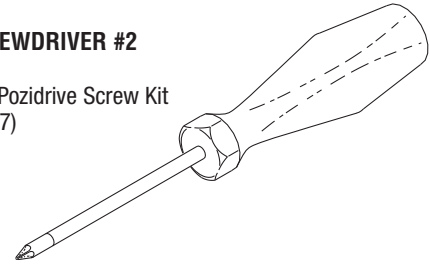

**RPI PART #RPK407  
METRIC POZIDRIVE® SCREW KIT**

- Kit includes 12-compartment storage case (RPI Part #RPB416)
- Stainless steel machine screw
- Screws are also sold separately in quantities indicated below

*This screwhead is common in Europe, and seen more frequently in the United States. It looks a lot like a Phillips screwhead, but it includes 4 more contacts. This helps to prevent stripping the screwhead.*

RPI PART #	SIZE	QTY
RPH115	M2 x 6 mm lg.	25
RPH116	M2.5 x 6 mm lg.	25
RPH117	M3 x 8 mm lg.	25
RPH118	M4 x 8 mm lg.	25
RPH119	M5 x 10 mm lg.	25
RPH120	M6 x 10 mm lg.	25
RPH121	M2 x 6 mm lg.	25
RPH122	M2.5 x 6 mm lg.	25
RPH123	M3 x 8 mm lg.	25
RPH124	M4 x 8 mm lg.	25
RPH125	M5 x 10 mm lg.	25
RPH126	M6 x 10 mm lg.	25

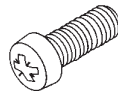

PAN HEAD

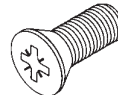

FLAT HEAD

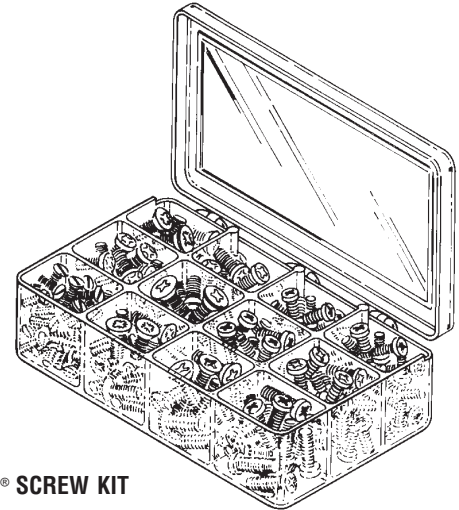

**RPK407  
METRIC POZIDRIVE® SCREW KIT**

**RPK408  
METRIC PHILLIPS MACHINE SCREW KIT**

**RPK409  
METRIC SLOTTED MACHINE SCREW KIT**

**RPI PART #RPK408  
METRIC PHILLIPS MACHINE SCREW KIT**

- Kit includes 12-compartment storage case (RPI Part #RPB416)
- Stainless steel
- Screws are also sold separately in quantities indicated below

RPI PART #	SIZE	QTY
RPH127	M2 x 6 mm lg.	25
RPH128	M2.5 x 6 mm lg.	25
RPH129	M3 x 8 mm lg.	25
RPH130	M4 x 8 mm lg.	25
RPH131	M5 x 10 mm lg.	25
RPH132	M6 x 10 mm lg.	25
RPH133	M2 x 6 mm lg.	25
RPH134	M2.5 x 6 mm lg.	25
RPH135	M3 x 8 mm lg.	25
RPH136	M4 x 8 mm lg.	25
RPH137	M5 x 10 mm lg.	25
RPH138	M6 x 10 mm lg.	25

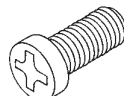

PAN HEAD

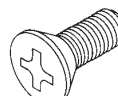

FLAT HEAD

**RPI PART #RPK409  
METRIC SLOTTED MACHINE SCREW KIT**

- Kit includes 12-compartment storage case (RPI Part #RPB416)
- Stainless steel
- Screws are also sold separately in quantities indicated below

RPI PART #	SIZE	QTY
RPH139	M2 x 6 mm lg.	25
RPH140	M2.5 x 6 mm lg.	25
RPH141	M3 x 8 mm lg.	25
RPH142	M4 x 8 mm lg.	25
RPH143	M5 x 10 mm lg.	25
RPH144	M6 x 10 mm lg.	25
RPH145	M2 x 6 mm lg.	25
RPH146	M2.5 x 6 mm lg.	25
RPH147	M3 x 8 mm lg.	25
RPH148	M4 x 8 mm lg.	25
RPH149	M5 x 10 mm lg.	25
RPH150	M6 x 10 mm lg.	25

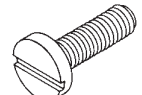

PAN HEAD

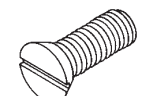

FLAT HEAD



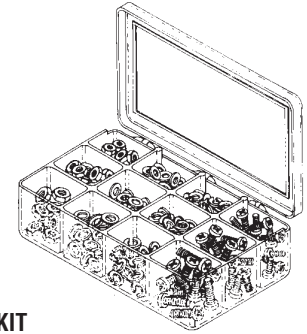

**RPI PART #RPK402  
HARDWARE KIT**

- Kit includes 12-compartment storage case (RPI Part #RPB416)
- Stainless steel machine screw
- Hardware is also sold separately in quantities indicated below

RPI PART #	SIZE	TYPE	QTY
RPH101	#6-32 x 1/2" lg.	PHILLIPS PAN HEAD	50
RPH102	#8-32 x 1/2" lg.	PHILLIPS PAN HEAD	50
RPH103	#10-24 x 3/4" lg.	PHILLIPS PAN HEAD	25
RPH104	#6	SPLIT LOCK WASHER	50
RPH105	#8	SPLIT LOCK WASHER	50
RPH106	#10	SPLIT LOCK WASHER	25
RPH107	#6	FLAT WASHER	50
RPH108	#8	FLAT WASHER	50
RPH109	#10	FLAT WASHER	25
RPH110	#6-32	HEX NUT	50
RPH111	#8-32	HEX NUT	50
RPH112	#10-24	HEX NUT	50

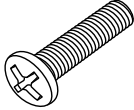

**RPK402  
HARDWARE KIT**

	
RPH101 - RPH103 PHILLIPS PAN HEAD SCREW	RPH107 - RPH109 FLAT WASHER
	
RPH104 - RPH106 SPLIT LOCK WASHER	RPH110 - RPH112 HEX NUT

**Stainless Steel Lock Washer Kit**

**RPI PART #RPK413  
LOCKWASHER KIT**

- Kit includes 18-compartment storage case (RPI Part #RPB417)
- Stainless steel
- Lockwashers are also sold separately in quantities indicated below

RPI PART #	SIZE	QTY
RPH173	#4	50
RPH174	#6	50
RPH175	#8	50
RPH176	#10	50
RPH177	1/4"	50
RPH178	5/16"	50
RPH179	3/8"	50
RPH180	7/16"	50
RPH181	1/2"	50
RPH182	#4	50
RPH183	#6	50
RPH184	#8	50
RPH185	#10	50
RPH186	1/4"	50
RPH187	5/16"	50
RPH188	3/8"	50
RPH189	7/16"	50
RPH190	1/2"	50



**INTERNAL TOOTH  
LOCK WASHER**



**EXTERNAL TOOTH  
LOCK WASHER**

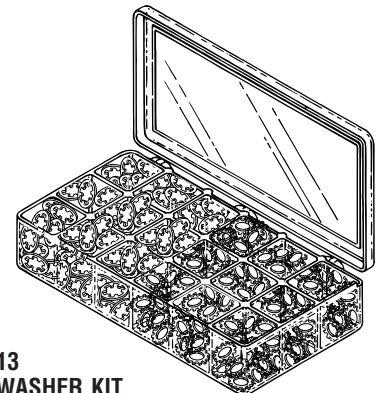

**RPK413  
LOCKWASHER KIT**

**RPI Part #RPA032  
THREADLOCKER 242**

- 5 per package
- .02 fl. oz. per unit
- Prevents rust and corrosion
- Removable adhesive by Loctite®
- MSDS and Technical Data sheet available on RPI website

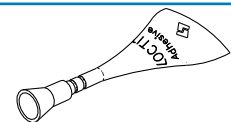

# General Shop Aids

## O-Ring (References)

### ETHYLENE PROPYLENE RUBBER (EPM, EPDM)

Temperature range: -65° to +300°F (-54° to +149°C).

**EP is recommended for:**

- Phosphate ester base hydraulic fluids
- Steam (to 400°F) (204°C)
- Water
- Silicone oils and greases
- Dilute acids
- Dilute alkalis
- Ketones (MEK, acetone)
- Alcohols

**EP is not recommended for:**

- Petroleum oils
- Di-ester base lubricants

### SILICONE RUBBER (SI)

Temperature range: -65° to +450°F (-54°C to +232°C).

**Silicones are recommended for:**

- Dynamic sealing application
- Dry heat
- High-aniline point oils
- Chlorinated di-phenyls

**Silicones are not recommended for:**

- Most petroleum fluids
- Ketones (MEK, acetone)
- Water and steam

### FLUOROCARBON RUBBER VITON (FKM)

Temperature range: -15° to +400°F (-29° to +204°C).

**FKM is recommended for:**

- Petroleum oils
- Di-ester base lubricants
- Silicate ester base lubricants
- Silicone fluids and greases
- Halogenated hydrocarbons (carbon tetrachloride, trichloroethylene)
- Selected phosphate ester fluids
- Acids

**FKM is not recommended for:**

- Ketones (MEK, acetone)
- Skydrol fluids

### NITRILE OR BUNA N (NBR)

Temperature range of -65° to +275°F (-54° to +135°C).

**Nitrile is recommended for:**

- General purpose sealing
- Petroleum oils and fluids
- Cold water
- Silicone greases and oils
- Di-Ester base lubricants
- Ethylene Glycol base fluids (Hydrolubes)

**Nitrile is not recommended for:**

- Halogenated hydrocarbons (carbon, tetrachloride, trichloroethylene)
- Nitro hydrocarbons (nitrobenzene, aniline)
- Phosphate ester hydraulic fluids (Skydrol, Fyrquel, Pydraul)
- Ketones (MEK, acetone)
- Strong acids
- Ozone

This information is provided as a guideline and quick reference for approximate identification of an O-ring. There may be many factors that need to be considered when determining proper O-ring material. Further investigation for a given application may be required. In addition, to more accurately determine the dimensions of an O-ring, precision measuring equipment (such as Calipers) should be used.

#### HOW TO USE THIS CHART

Lay O-ring over cross-section pictorials to determine approximate cross-section diameter. (For best results cut O-ring and place round cross-section onto pictorial.)

#### STANDARD CROSS-SECTIONS PER AS568A

- .031
- .039
- .041
- QUAD .041
- .051
- .063
- .079
- .080
- .040
- .050
- .060
- .070
- .103
- .139
- .210

#### OTHER AVAILABLE CROSS-SECTIONS

#### HOW TO USE THIS CHART

1. Align outer edge of O-ring to the 0.00 line.
2. Read opposite edge of O-ring for approximate outside diameter (O.D.).

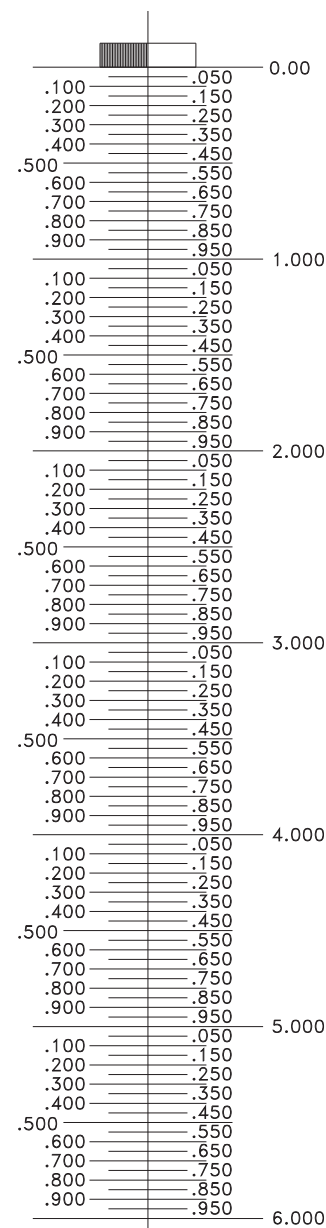

Source of information: Parker O-Ring Handbook, Parker Seals, ORD5700, Parker Hannifin Corporation, Cleveland, OH

O-RING CHART BY SIZE

RPI	PART #	X-SEC	ID	OD	IND PART #	MATERIAL	DURO	QTY
	RP0324	.031	.239	.301	Custom	Nitrile (Buna N)	70	12
	RP0328	.031	.288	.351	Metric	Nitrile (Buna N)	70	12
	RP0493	.038	.032	.108	Custom	EPDM	70	12
	RP0309	.040	.029	.109	AS568A-001	Nitrile (Buna N)	70	12
	RP0308	.040	.070	.150	5-051	Nitrile (Buna N)	70	12
	RP0496	.040	.070	.150	Custom	EPDM	70	12
	RP0494	.040	.176	.256	Custom	EPDM	70	12
	RP0497	.040	.176	.256	Custom	Viton	75	12
	RP0319	.041-Q	.028	.110	Q4001	Nitrile (Buna N)	70	12
	RP0310	.050	.042	.142	AS568A-002	Nitrile (Buna N)	70	12
	RP0352	.050	.042	.142	AS568A-002	Viton	90	12
	RP0486	.050	.042	.142	AS568A-002	EPDM	70	12
	RP0450	.051	.547	.649	5-001	Silicone	70	6
	RP0311	.060	.056	.176	AS568A-003	Nitrile (Buna N)	70	12
	RP0484	.060	.056	.176	AS568A-003	Viton	75	12
	RP0487	.060	.056	.176	AS568A-003	EPDM	70	12
	RP0495	.062	.400	.524	Custom	Viton	75	12
	RP0312	.070	.070	.210	AS568A-004	Nitrile (Buna N)	70	12
	RP0313	.070	.101	.241	AS568A-005	Nitrile (Buna N)	70	12
	RP0489	.070	.101	.241	AS568A-005	EPDM	70	12
	RP0307	.070	.114	.254	AS568A-006	EPDM	70	12
	RP0320	.070	.114	.254	AS568A-006	Viton	70	12
	RP0314	.070	.145	.285	AS568A-007	Nitrile (Buna N)	70	12
	RP0342	.070	.145	.285	AS568A-007	Viton	70	12
	RP0359	.070	.145	.285	AS568A-007	EPDM	70	6
	RP0306	.070	.176	.316	AS568A-008	EPDM	70	12
	RP0327	.070	.176	.316	AS568A-008	Natural Silicone	70	12
	RP0330	.070	.176	.316	AS568A-008	Teflon	n/a	6
	RP0315	.070	.208	.348	AS568A-009	Nitrile (Buna N)	70	12
	RP0339	.070	.208	.348	AS568A-009	Viton	70	12
	RP0492	.070	.208	.348	AS568A-009	Silicone	70	12
	RP0305	.070	.239	.379	AS568A-010	Nitrile (Buna N)	70	12
	RP0329	.070	.239	.379	AS568A-010	Teflon	n/a	6
	RP0386	.070	.239	.379	AS568A-010	Silicone	70	6
	RP0304	.070	.301	.441	AS568A-011	Nitrile (Buna N)	70	12
	RP0331	.070	.301	.441	AS568A-011	Neoprene	70	6
	RP0343	.070	.301	.441	AS568A-011	Silicone	70	12
	RP0360	.070	.301	.441	AS568A-011	EPDM	80	6
	RP0385	.070	.301	.441	AS568A-011	Viton	60	12
	RP0303	.070	.364	.504	AS568A-012	Nitrile (Buna N)	70	12
	RP0498	.070	.364	.504	AS568A-012	EPDM	70	12

RPI	PART #	X-SEC	ID	OD	IND PART #	MATERIAL	DURO	QTY
	RP0302	.070	.426	.566	AS568A-013	Nitrile (Buna N)	70	12
	RP0388	.070	.426	.566	AS568A-013	Silicone	70	6
	RP0485	.070	.426	.566	AS568A-013	EPDM	70	12
	RP0301	.070	.489	.629	AS568A-014	Nitrile (Buna N)	70	12
	RP0326	.070	.489	.629	AS568A-014	Viton	70	12
	RP0488	.070	.489	.625	AS568A-014	EPDM	70	12
	RP0316	.070	.551	.691	AS568A-015	Nitrile (Buna N)	70	12
	RP0341	.070	.551	.691	AS568A-015	Viton	70	12
	RP0439	.070	.551	.691	AS568A-015	EPDM	70	6
	RP0317	.070	.614	.754	AS568A-016	Nitrile (Buna N)	70	12
	RP0318	.070	.676	.816	AS568A-017	Nitrile (Buna N)	70	12
	RP0334	.070	.739	.879	AS568A-018	Nitrile (Buna N)	70	12
	RP0340	.070	.739	.879	AS568A-018	Viton	70	12
	RP0490	.070	.739	.879	AS568A-018	EPDM	70	12
	RP0325	.070	.801	.941	AS568A-019	Nitrile (Buna N)	70	12
	RP0355	.070	.801	.941	AS568A-019	Silicone	70	6
	RP0444	.070	.801	.941	AS568A-019	EPDM	70	12
	RP0438	.070	.864	1.004	AS568A-020	EPDM	70	12
	RP0354	.070	.926	1.066	AS568A-021	Silicone	70	6
	RP0322	.070	1.051	1.191	AS568A-023	Nitrile (Buna N)	70	12
	RP0390	.070	1.114	1.254	AS568A-024	Silicone	70	6
	RP0335	.070	1.489	1.629	AS568A-029	Nitrile (Buna N)	70	12
	RP0344	.070	2.239	2.379	AS568A-035	Nitrile (Buna N)	70	6
	RP0321	.070	2.114	2.254	AS568A-034	Nitrile (Buna N)	70	12
	RP0491	.103	.206	.412	AS568A-107	EPDM	70	12
	RP0448	.103	.237	.443	AS568A-108	EPDM	70	6
	RP0323	.103	.362	.568	AS568A-110	Nitrile (Buna N)	70	12
	RP0387	.103	.362	.568	AS568A-110	Silicone	70	6
	RP0395	.103	.362	.568	AS568A-110	EPDM	70	12
	RP0356	.103	.424	.630	AS568A-111	Nitrile (Buna N)	70	12
	RP0357	.103	.424	.630	AS568A-111	EPDM	70	12
	RP0353	.103	.487	.693	AS568A-112	Nitrile (Buna N)	70	12
	RP0358	.103	.549	.755	AS568A-113	EPDM	80	6
	RP0389	.103	1.049	1.255	AS568A-121	Silicone	70	6
	RP0346	.103	2.425	2.631	AS568A-143	Nitrile (Buna N)	70	12
	LI0005	.103	3.987	4.193	AS568A-155	Nitrile (Buna N)	70	1
	RP0244	.139	.296	.574	AS568A-203	Silicone	60	6
	RP0350	.139	.796	1.074	AS568A-211	Nitrile (Buna N)	70	12
	RP0345	.139	4.359	4.637	AS568A-245	Nitrile (Buna N)	70	6
	RP0361	.210	.912	1.332	AS568A-317	Nitrile (Buna N)	70	6

O-rings are sold separately in quantities indicated above. For O-ring Kits, see pages 503-504.

## O-RING CHART BY RPI PART #

RPI PART #	X-SEC	ID	OD	IND PART #	MATERIAL	DURO	QTY
LI0005	.103	3.987	4.193	AS568A-155	Nitrile (Buna N)	70	1
RP0244	.139	.296	.574	AS568A-203	Silicone	60	6
RP0301	.070	.489	.629	AS568A-014	Nitrile (Buna N)	70	12
RP0302	.070	.426	.566	AS568A-013	Nitrile (Buna N)	70	12
RP0303	.070	.364	.504	AS568A-012	Nitrile (Buna N)	70	12
RP0304	.070	.301	.441	AS568A-011	Nitrile (Buna N)	70	12
RP0305	.070	.239	.379	AS568A-010	Nitrile (Buna N)	70	12
RP0306	.070	.176	.316	AS568A-008	EPDM	70	12
RP0307	.070	.114	.254	AS568A-006	EPDM	70	12
RP0308	.040	.070	.150	5-051	Nitrile (Buna N)	70	12
RP0309	.040	.029	.109	AS568A-001	Nitrile (Buna N)	70	12
RP0310	.050	.042	.142	AS568A-002	Nitrile (Buna N)	70	12
RP0311	.060	.056	.176	AS568A-003	Nitrile (Buna N)	70	12
RP0312	.070	.070	.210	AS568A-004	Nitrile (Buna N)	70	12
RP0313	.070	.101	.241	AS568A-005	Nitrile (Buna N)	70	12
RP0314	.070	.145	.285	AS568A-007	Nitrile (Buna N)	70	12
RP0315	.070	.208	.348	AS568A-009	Nitrile (Buna N)	70	12
RP0316	.070	.551	.691	AS568A-015	Nitrile (Buna N)	70	12
RP0317	.070	.614	.754	AS568A-016	Nitrile (Buna N)	70	12
RP0318	.070	.676	.816	AS568A-017	Nitrile (Buna N)	70	12
RP0319	.041-Q	.028	.110	Q4001	Nitrile (Buna N)	70	12
RP0320	.070	.114	.254	AS568A-006	Viton	70	12
RP0321	.070	2.114	2.254	AS568A-034	Nitrile (Buna N)	70	12
RP0322	.070	1.051	1.191	AS568A-023	Nitrile (Buna N)	70	12
RP0323	.103	.362	.568	AS568A-110	Nitrile (Buna N)	70	12
RP0324	.031	.239	.301	Custom	Nitrile (Buna N)	70	12
RP0325	.070	.801	.941	AS568A-019	Nitrile (Buna N)	70	12
RP0326	.070	.489	.629	AS568A-014	Viton	70	12
RP0327	.070	.176	.316	AS568A-008	Natural Silicone	70	12
RP0328	.031	.288	.351	Metric	Nitrile (Buna N)	70	12
RP0329	.070	.239	.379	AS568A-010	Teflon	n/a	6
RP0330	.070	.176	.316	AS568A-008	Teflon	n/a	6
RP0331	.070	.301	.441	AS568A-011	Neoprene	70	6
RP0334	.070	.739	.879	AS568A-018	Nitrile (Buna N)	70	12
RP0335	.070	1.489	1.629	AS568A-029	Nitrile (Buna N)	70	12
RP0339	.070	.208	.348	AS568A-009	Viton	70	12
RP0340	.070	.739	.879	AS568A-018	Viton	70	12
RP0341	.070	.551	.691	AS568A-015	Viton	70	12
RP0342	.070	.145	.285	AS568A-007	Viton	70	12
RP0343	.070	.301	.441	AS568A-011	Silicone	70	12
RP0344	.070	2.239	2.379	AS568A-035	Nitrile (Buna N)	70	6

RPI PART #	X-SEC	ID	OD	IND PART #	MATERIAL	DURO	QTY
RP0345	.139	4.359	4.637	AS568A-245	Nitrile (Buna N)	70	6
RP0346	.103	2.425	2.631	AS568A-143	Nitrile (Buna N)	70	12
RP0350	.139	.796	1.074	AS568A-211	Nitrile (Buna N)	70	12
RP0352	.050	.042	.142	AS568A-002	Viton	90	12
RP0353	.103	.487	.693	AS568A-112	Nitrile (Buna N)	70	12
RP0354	.070	.926	1.066	AS568A-021	Silicone	70	6
RP0355	.070	.801	.941	AS568A-019	Silicone	70	6
RP0356	.103	.424	.630	AS568A-111	Nitrile (Buna N)	70	12
RP0357	.103	.424	.630	AS568A-111	EPDM	70	12
RP0358	.103	.549	.755	AS568A-113	EPDM	80	6
RP0359	.070	.145	.285	AS568A-007	EPDM	70	6
RP0360	.070	.301	.441	AS568A-011	EPDM	80	6
RP0361	.210	.912	1.332	AS568A-317	Nitrile (Buna N)	70	6
RP0385	.070	.301	.441	AS568A-011	Viton	60	12
RP0386	.070	.239	.379	AS568A-010	Silicone	70	6
RP0387	.103	.362	.568	AS568A-110	Silicone	70	6
RP0388	.070	.426	.566	AS568A-013	Silicone	70	6
RP0389	.103	1.049	1.255	AS568A-121	Silicone	70	6
RP0390	.070	1.114	1.254	AS568A-024	Silicone	70	6
RP0395	.103	.362	.568	AS568A-110	EPDM	70	12
RP0438	.070	.864	1.004	AS568A-020	EPDM	70	12
RP0439	.070	.551	.691	AS568A-015	EPDM	70	6
RP0444	.070	.801	.941	AS568A-019	EPDM	70	12
RP0448	.103	.237	.443	AS568A-108	EPDM	70	6
RP0450	.051	.547	.649	5-001	Silicone	70	6
RP0484	.060	.056	.176	AS568A-003	Viton	75	12
RP0485	.070	.426	.566	AS568A-013	EPDM	70	12
RP0486	.050	.042	.142	AS568A-002	EPDM	70	12
RP0487	.060	.056	.176	AS568A-003	EPDM	70	12
RP0488	.070	.489	.625	AS568A-014	EPDM	70	12
RP0489	.070	.101	.241	AS568A-005	EPDM	70	12
RP0490	.070	.739	.879	AS568A-018	EPDM	70	12
RP0491	.103	.206	.412	AS568A-107	EPDM	70	12
RP0492	.070	.208	.348	AS568A-009	Silicone	70	12
RP0493	.038	.032	.108	Custom	EPDM	70	12
RP0494	.040	.176	.256	Custom	EPDM	70	12
RP0495	.062	.400	.524	Custom	Viton	75	12
RP0496	.040	.070	.150	Custom	EPDM	70	12
RP0497	.040	.176	.256	Custom	Viton	75	12
RP0498	.070	.364	.504	AS568A-012	EPDM	70	12

O-rings are sold separately in quantities indicated above. For O-ring Kits, see pages 503-504.

### RPI Part #RPK481

#### O-RING INSTALLATION TOOLS

- Three sizes
- Accommodates O-rings with ID of .029" through .208"
- Stainless steel
- ~1-3/4" lg.

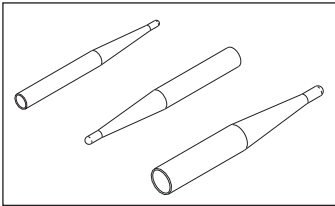

### RPI Part #RPK581

#### O-RING REMOVAL TOOLS

- Pointed ends for hard to reach areas
- Blunt ends for larger surfaces
- Brass (to reduce potential o-ring groove damage)
- ~5-1/2" lg.

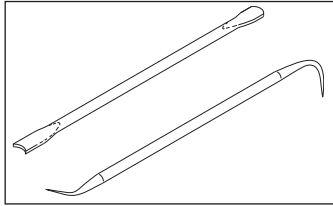

### RPI Part #RPL090

#### HIGH TEMP LUBRICANT

- 5 per package
- 1/2 gram per unit
- Non-silicone lubricant
- Temperature range: -40° to +400°F (-40° to +204°C)
- MSDS and Technical Data sheet available on RPI website

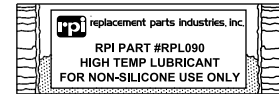

### RPI PART #RPK403

#### O-RING KIT

- Kit includes 8-compartment storage case (RPI Part #RPB414)
- O-rings are also sold separately in quantities indicated below

#### RPI

PART #	X-SEC	ID	OD	IND PART #	MATERIAL	DURO	QTY
RPO301	.070	.489	.629	AS568A-014	Nitrile (Buna N)	70	12
RPO302	.070	.426	.566	AS568A-013	Nitrile (Buna N)	70	12
RPO303	.070	.364	.504	AS568A-012	Nitrile (Buna N)	70	12
RPO304	.070	.301	.441	AS568A-011	Nitrile (Buna N)	70	12
RPO305	.070	.239	.379	AS568A-010	Nitrile (Buna N)	70	12
RPO306	.070	.176	.316	AS568A-008	EPDM	70	12
RPO307	.070	.114	.254	AS568A-006	EPDM	70	12
RPO308	.040	.070	.150	5-051	Nitrile (Buna N)	70	12

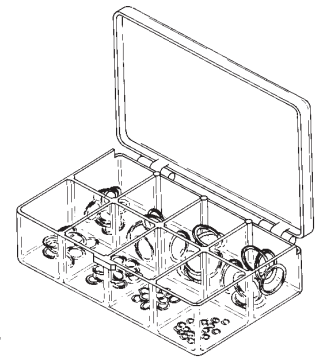

RPK403  
O-RING KIT

### RPI PART #RPK404

#### O-RING KIT

- Kit includes 18-compartment storage case (RPI Part #RPB417)
- O-rings are also sold separately in quantities indicated below

#### RPI

PART #	X-SEC	ID	OD	IND PART #	MATERIAL	DURO	QTY
RPO301	.070	.489	.629	AS568A-014	Nitrile (Buna N)	70	12
RPO302	.070	.426	.566	AS568A-013	Nitrile (Buna N)	70	12
RPO303	.070	.364	.504	AS568A-012	Nitrile (Buna N)	70	12
RPO304	.070	.301	.441	AS568A-011	Nitrile (Buna N)	70	12
RPO305	.070	.239	.379	AS568A-010	Nitrile (Buna N)	70	12
RPO306	.070	.176	.316	AS568A-008	EPDM	70	12
RPO307	.070	.114	.254	AS568A-006	EPDM	70	12
RPO308	.040	.070	.150	5-051	Nitrile (Buna N)	70	12
RPO309	.040	.029	.109	AS568A-001	Nitrile (Buna N)	70	12
RPO310	.050	.042	.142	AS568A-002	Nitrile (Buna N)	70	12
RPO311	.060	.056	.176	AS568A-003	Nitrile (Buna N)	70	12
RPO312	.070	.070	.210	AS568A-004	Nitrile (Buna N)	70	12
RPO313	.070	.101	.241	AS568A-005	Nitrile (Buna N)	70	12
RPO314	.070	.145	.285	AS568A-007	Nitrile (Buna N)	70	12
RPO315	.070	.208	.348	AS568A-009	Nitrile (Buna N)	70	12
RPO316	.070	.551	.691	AS568A-015	Nitrile (Buna N)	70	12
RPO317	.070	.614	.754	AS568A-016	Nitrile (Buna N)	70	12
RPO318	.070	.676	.816	AS568A-017	Nitrile (Buna N)	70	12

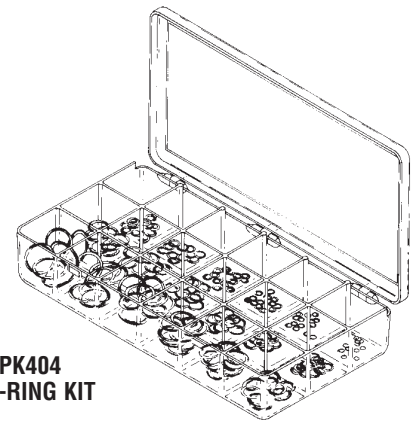

RPK404  
O-RING KIT





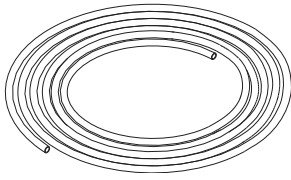

**RPI Part #RPT544**

**3/16" COPPER TUBING**

- .188" OD x .030" wall
- Soft annealed copper
- 10 ft. flat pack coil
- Suitable for compressed air, steam, water, vacuum or hydraulic applications
- Not for use in oxygen system



**RPI Part #RPT545**

**1/4" COPPER TUBING**

- .250" OD x .030" wall
- Soft annealed copper
- 10 ft. flat pack coil
- Suitable for compressed air, steam, water, vacuum or hydraulic applications
- Not for use in oxygen system



**RPI Part #RPT546**

**5/16" COPPER TUBING**

- .312" OD x .032" wall
- Soft annealed copper
- 10 ft. flat pack coil
- Suitable for compressed air, steam, water, vacuum or hydraulic applications
- Not for use in oxygen system



**RPI Part #RPT547**

**3/8" COPPER TUBING**

- .375" OD x .032" wall
- Soft annealed copper
- 10 ft. flat pack coil
- Suitable for compressed air, steam, water, vacuum or hydraulic applications
- Not for use in oxygen system



**RPI Part #RPT548**

**METAL TUBING CUTTER**

- ~2" lg.
- Chromed steel
- 1/8" - 5/8" OD tubing capacity
- Can be used where clearance around tubing is limited.

- Replaceable cutting wheel (RPI Part #RPT549)
- Made by Blue Point® for Snap-On®

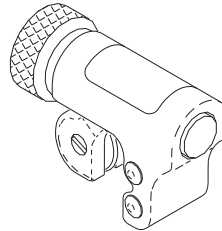

**RPI Part #RPT549**

**TUBING CUTTER WHEEL**

- Carbon steel
- Replacement part for RPI Part #RPT548



**RPI Part #RPT550**

**METAL TUBING BENDER**

- ~8-1/4" lg.
- Handles 3/16", 1/4", 5/16" and 3/8" OD metal tubing
- Made by Blue Point® for Snap-On®
- Makes left, right or offset bends up to 90°

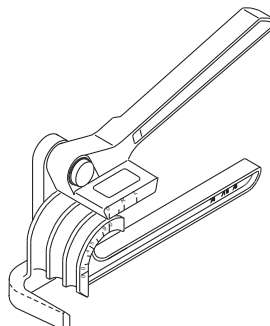

**RPI Part #RPT579**

**1/4" TEFLON THREAD SEALING TAPE**

- 5 per package
- 1/4" x 260" per unit

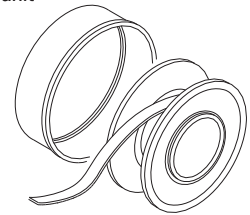

**RPI Part #RPT580**

**1/2" TEFLON THREAD SEALING TAPE**

- 5 per package
- 1/2" x 260" per unit

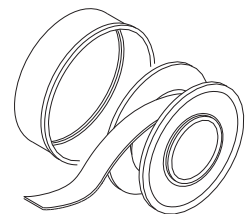

**RPI Part #RPA459**

**PIPE SEALANT 567**

- .20 fl. oz. (6ml)
- Temperature range: -65° to 400°F (-54° to 204°C)
- MSDS and Technical Data sheet available on RPI website

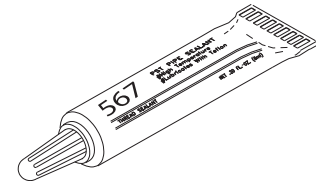

**RPI Part #RPA369**

**THREADLOCKER 545**

- 5 per package
- .02 fl. oz. per unit
- Temperature range of -65° to 300°F (-54° to 149°C)
- Seals operating pressures up to 10,000 PSI
- For use on all pneumatic and hydraulic fittings
- MSDS and Technical Data sheet available on RPI website

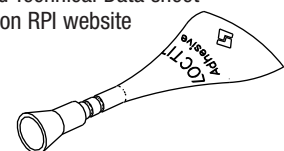

# General Shop Aids

## Plumbing (Compression Fittings, and Accessories)

### RPI Part #RPA369

#### THREADLOCKER 545

- 5 per package
- .02 fl. oz. per unit
- Temperature range of -65° to 300°F (-54° to 149°C)
- Seals operating pressures up to 10,000 PSI
- For use on all pneumatic and hydraulic fittings
- MSDS and Technical Data sheet available on RPI website

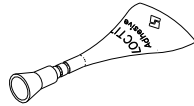

### RPI Part #RPA459

#### PIPE SEALANT 567

- .20 fl. oz. (6ml) per unit
- Temperature range: -65° to 400°F (-54° to 204°C)
- MSDS and Technical Data sheet available on RPI website

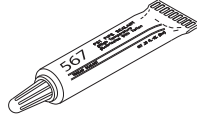

### RPI Part #RPT579

#### 1/4" TEFLON THREAD SEALING TAPE

- 5 per package
- 1/4" x 260" per unit

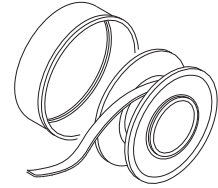

### RPI Part #RPT580

#### 1/2" TEFLON THREAD SEALING TAPE

- 5 per package
- 1/2" x 260" per unit

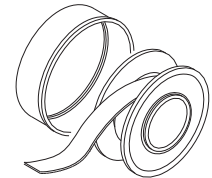

RPK420  
COMPRESSION FITTING KIT

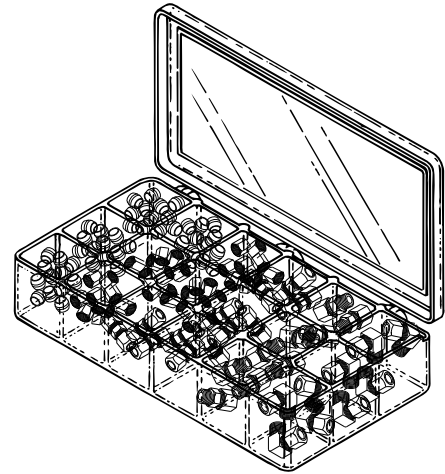

### RPI PART #RPK420

#### COMPRESSION FITTING KIT

- Kit includes 18-compartment storage case (RPI Part #RPB419)
- Brass
- Fittings also sold separately in quantities indicated below

RPI PART #	FITS TUBE OD	PIPE THREADS	STRAIGHT THREADS	HEX SIZE	QTY
RPF215	3/16" OD	N/A	N/A	N/A	5
RPF216	1/4" OD	N/A	N/A	N/A	10
RPF217	5/16" OD	N/A	N/A	N/A	5
RPF218	3/8" OD	N/A	N/A	N/A	5
RPF219	3/16" OD	N/A	3/8-24	7/16"	5
RPF220	1/4" OD	N/A	7/16-24	1/2"	5
RPF221	5/16" OD	N/A	1/2-24	9/16"	5
RPF222	3/8" OD	N/A	9/16-24	5/8"	5
RPF223	3/16" OD	N/A	3/8-24	7/16"	5
RPF224	1/4" OD	N/A	7/16-24	1/2"	5
RPF225	5/16" OD	N/A	1/2-24	9/16"	5
RPF226	3/8" OD	N/A	9/16-24	5/8"	2
RPF227	3/16" OD	1/8 MPT	3/8-24	7/16"	2
RPF228	1/4" OD	1/8 MPT	7/16-24	1/2"	5
RPF229	5/16" OD	1/8 MPT	1/2-24	9/16"	2
RPF230	3/16" OD	1/8 MPT	3/8-24	N/A	2
RPF231	1/4" OD	1/8 MPT	7/16-24	N/A	5
RPF232	5/16" OD	1/8 MPT	1/2-24	N/A	2



RPF215 - RPF218  
COMPRESSION SLEEVE



RPF219 - RPF222  
COMPRESSION NUT



RPF223 - RPF226  
COMPRESSION UNION

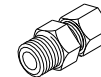

RPF227 - RPF229  
MALE CONNECTOR



RPF230 - RPF232  
MALE ELBOW

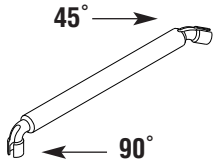

RPI Part #RPT294

**1/8" SLEEVE TOOL**

- Use on 1/8" OD tubing
- The tool provides 90° and 45° angles for ease of use
- ~5" lg.

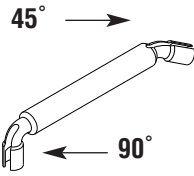

RPI Part #RPT295

**1/4" SLEEVE TOOL**

- Use on 1/4" OD tubing
- The tool provides 90° and 45° angles for ease of use
- ~5" lg.

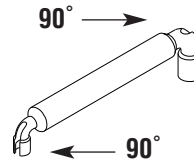

RPI Part #RPT296

**UNIVERSAL SLEEVE TOOL**

- Use on 1/8" OD tubing and 1/4" OD tubing
- The tool provides 90° angles on both ends for ease of use
- ~5" lg.

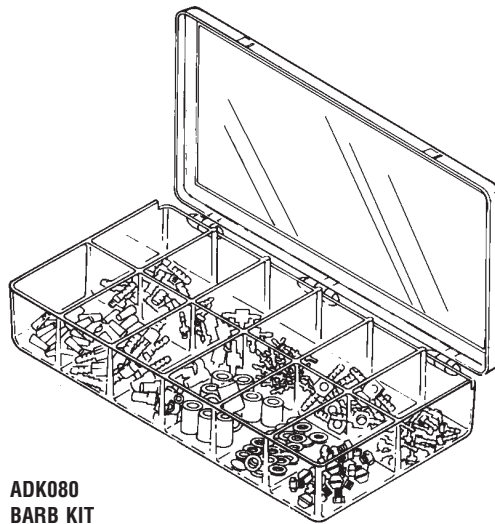

ADK080  
BARB KIT

**RPI PART #ADK080  
BARB KIT**

- Kit includes 12-compartment storage case (RPI Part #RPB415)
- Barbs are also sold separately in quantities indicated below

RPI PART #	DESCRIPTION	MATERIAL	FITS	KIT QTY	REORDER QTY
ADB011	1/8" BARB TO #10-32 MALE THREAD	BRASS	1/8" ID TUBING	20	10
ADB012	1/16" BARB TO #10-32 MALE THREAD	BRASS	1/16" ID TUBING	20	10
ADB013	1/16" BARB TEE	NYLON	1/16" ID TUBING	20	10
ADB014	1/16" INLINE BARB	BRASS	1/16" ID TUBING	20	10
ADB015	1/8" BARB TEE-BODY WITH #10-32 FEMALE THREAD	BRASS	1/8" ID TUBING	10	5
ADB016	1/16" BARB TUBING PLUG	BRASS	1/16" ID TUBING	20	10
ADB018	1/8" INLINE BARB	BRASS	1/8" ID TUBING	10	5
ADC017	1/16" BARB CAP	POLYURETHANE	1/16" ID BARB	20	10
ADC034	UNI-CLAMP	DELIRIN	1/8" OD BARB	40	20
ADC035	SLEEVE CLAMP	POLYETHYLENE	1/4" OD TUBING	20	20
ADP057	HEX PLUG WITH #10-32 MALE THREAD	BRASS	#10-32 FEMALE THREAD	20	10
ADW038	FLAT WASHER (.187" ID x .312" OD x .031" Thk)	NYLON	#10-32 MALE THREAD	100	50

ADB011 BARB	
ADB012 BARB	
ADB013 BARB TEE	
ADB014 INLINE BARB	
ADB015 BARB TEE-BODY	
ADB016 BARB TUBING PLUG	
ADB018 INLINE BARB	
ADC017 BARB CAP	
ADC034 UNI-CLAMP	
ADC035 SLEEVE CLAMP	
ADP057 HEX PLUG	
ADW038 FLAT WASHER	

General Shop Aids

Tools

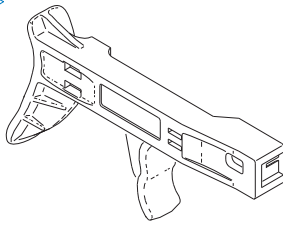

RPI Part #RPT477

**CABLE TIE TOOL**

- Plastic
- Use this tool for applying a wide variety of ties making for fast application and a clean cut-off
- A lightweight pocket sized tool
- .094" to .184" tie width
- ~6-1/2" lg.
- Made by Thomas & Betts

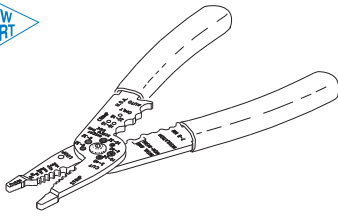

RPI Part #RPT482

**TERMINAL CRIMP TOOL**

- ~8-1/4" lg.
- Steel with cushion grip handles
- Wire stripper - AWG #10 to #22
- Crimps #10 to #22 insulated and non-insulated terminals
- Cuts #4-40 to #10-32 screws
- Hardened pivot joint bushing for long life
- Includes pliers at tip, wire loop former and wire cutter
- Made by Blue Point® for Snap-On®

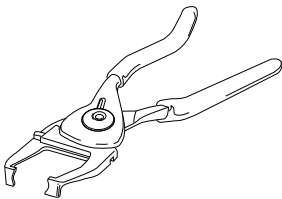

RPI Part #RPT172

**STRAIN RELIEF BUSHING PLIERS**

- Hand pliers adjustable for all bushings that assemble into mounting hole up to 7/8" diameter
- ~7" lg.

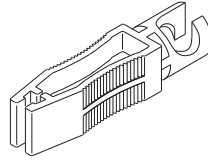

RPI Part #RPT502

**FUSE PULLER**

- ~2" lg.
- Yellow polycarbonate
- Non-slip handle
- Removes or installs glass, ceramic or blade style fuses
- Ideal for tight spaces

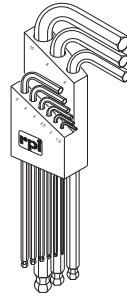

RPI Part #RPT539

**L-HEX WRENCH SET (METRIC)**

- 9 piece set
- 1.5mm through 10mm
- Corrosion protected steel
- Made by Bondus®

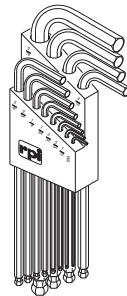

RPI Part #RPT540

**L-HEX WRENCH SET (INCH)**

- 13 piece set
- .050" through 3/8"
- Corrosion protected steel
- Made by Bondus®

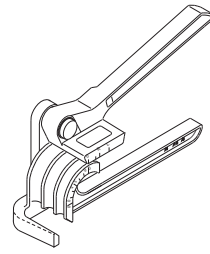

RPI Part #RPT550

**METAL TUBING BENDER**

- ~8-1/4" lg.
- Handles 3/16", 1/4", 5/16" and 3/8" OD metal tubing
- Made by Blue Point® for Snap-On®
- Makes left, right or offset bends up to 90°

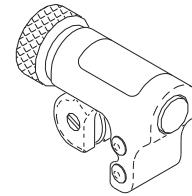

RPI Part #RPT548

**METAL TUBING CUTTER**

- ~2" lg.
- Chromed steel
- 1/8" - 5/8" OD tubing capacity
- Can be used where clearance around tubing is limited.
- Replaceable cutting wheel (RPI Part # RPT549)
- Made by Blue Point® for Snap-On®



RPI Part #RPT549

**TUBING CUTTER WHEEL**

- Carbon steel
- Replacement part for RPI Part #RPT548

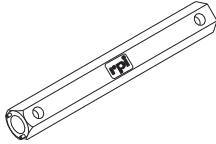

**RPI Part #RPT501**

**DOUBLE ENDED SPANNER WRENCH**

- ~7" lg.; .875" Hex
- Dimensions at one end: .453" ID; .062" pin diameter at .587" apart. Dimensions at other end: .530" ID; .094" pin diameter at .750" apart
- Stainless steel
- Can be used in place of the Spanner Nuts (RPI Part #'s ILS014 and RPT364)
- Convenient to use when repairing difficult to reach solenoid valves in Pelton & Crane, Midmark, and Scican sterilizers, and Instrumentation Laboratories analyzers

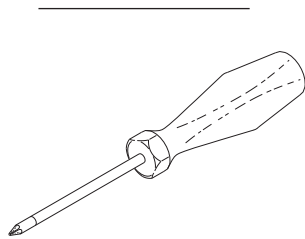

**RPI Part #RPT151**

**POZIDRIVE® SCREWDRIVER #1**

- ~6-1/2" lg.

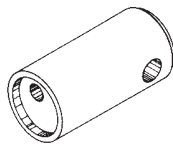

**RPI Part #STT010**

**CAM TOOL**

- ~3/4" dia. x 1-1/2" lg.
- Stainless steel
- To install/remove cam that fits Stryker cast cutter saws



**RPI Part #ILS014**

**SPANNER NUT**

- ID: .525", Hex: .875", Thk: .250"
- Dimensions: .109" diameter dowel pins at .750" apart
- Stainless steel
- For use when repairing solenoid valves in Midmark and Pelton & Crane sterilizers, and Instrumentation Laboratories analyzers

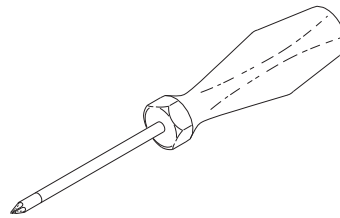

**RPI Part #RPT152**

**POZIDRIVE® SCREWDRIVER #2**

- ~8" lg.

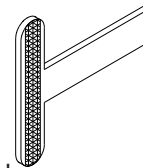

**RPI Part #RPT092**

**VALVE SEAT WRENCH**

- Stainless steel
- Use to remove and install air valve seat and body
- ~3" lg. x 2-3/4"

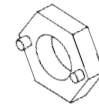

**RPI Part #RPT364**

**SPANNER NUT**

- ID: .453", Hex: .750", Thk: .250"
- Dimensions: .062" diameter dowel pins at .587" apart
- Stainless steel
- For use when repairing solenoid valves in Scican sterilizers

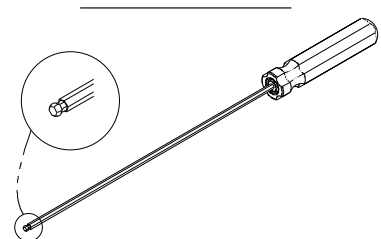

**RPI Part #RPT297**

**5/64" HEX x 7" LONG BALLDRIVER**

- 5/64" hex
- 7" long steel tool with plastic handle
- Precision ballpoint

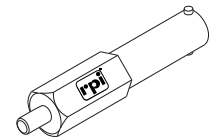

**RPI Part #RPT271**

**VALVE SEAT TOOL**

- 3-3/8" lg. x 5/8" Hex
- Stainless steel
- For installation and removal of air valve seat and body on Pelton & Crane sterilizers



**RPI Part #RPT460**

**TRIM POT ADJUSTMENT TOOL**

- ~5" lg.
- Plastic with stainless steel blades
- Includes shirt pocket clip
- Fits most trim pots

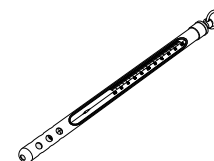

**RPI Part #RPT113**

**MAX REGISTER THERMOMETER**

- Mercury
- Length: 5-1/2"
- Accuracy Rating: ±1Division (±2°F)
- Range: 150° F to 350° F
- Includes thermometer, and metal protective case
- Use for temperature verification in sterilizers

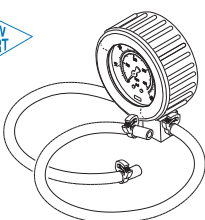

**RPT462 12" (x2)**  
For replacement tubing by the foot, see RPT462

**RPI Part #RPG461**

**TEST PRESSURE GAUGE**

- Includes all parts as shown
- Dual gauge display: 0-60 PSI/0-400 KPA
- Gauge has rubber cover protector
- Tubing length on each side: 12" lg.
- Can be used on most sterilizers for in-line pressure check

# General Shop Aids

Tools - Continued

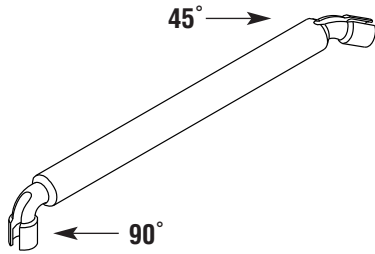

**RPI Part #RPT294**

**1/8" SLEEVE TOOL**

- Use on 1/8" OD tubing
- Use to install 1/8" Sleeve clamps and Uni-clamp (RPI Part #ADC034)
- The tool provides 90° and 45° angles for ease of use
- ~5" lg.

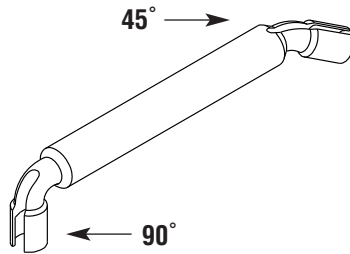

**RPI Part #RPT295**

**1/4" SLEEVE TOOL**

- Use on 1/4" OD tubing
- Use to install 1/4" Sleeve clamps and Uni-clamp (RPI Part #ADC035)
- The tool provides 90° and 45° angles for ease of use
- ~5" lg.

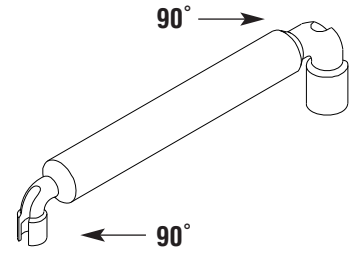

**RPI Part #RPT296**

**UNIVERSAL SLEEVE TOOL**

- Use on 1/4" OD tubing and 1/8" OD tubing
- Use to install 1/4" Sleeve clamp (RPI Part #ADC035) and 1/8" Uni-clamp (RPI Part #ADC034)
- The tool provides 90° angles on both ends for ease of use
- ~5" lg.

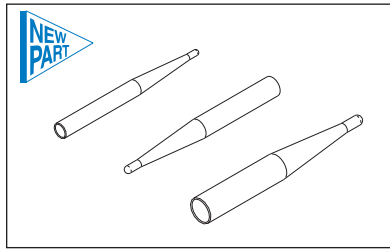

**RPI Part #RPK481**

**O-RING INSTALLATION TOOLS**

- Three sizes
- Accommodates O-rings with ID of .029" through .208"
- Stainless steel
- ~1-3/4" lg.

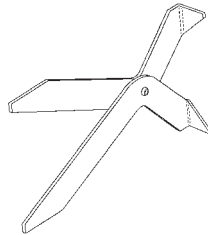

**RPI Part #PCT685**

**SOCKET RETRACTOR TOOL**

- ~3-1/4" lg. x 3-1/4"
- For installation and removal of the light bulb used in the Pelton & Crane LF units

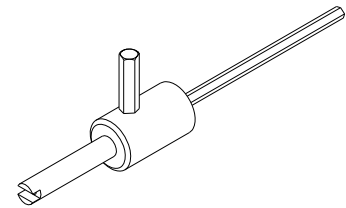

**RPI Part #RPT264**

**VALVE CORE REMOVAL SYRINGE TOOL**

- Long Allen 3/32"; Short Allen 5/32"
- Stainless steel
- ~3" lg.
- Syringe repair tool
- Removal tool for use with Valve Core (RPI Part #ADV001)

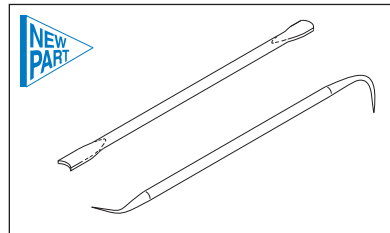

**RPI Part #RPK581**

**O-RING REMOVAL TOOLS**

- Pointed ends for hard to reach areas
- Blunt edges for larger surfaces
- Brass to reduce potential o-ring groove damage
- ~6" lg.

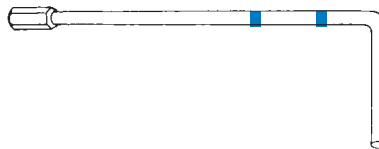

**RPI Part #PCT615**

**GAS SPRING TOOL**

- For gas/mechanical spring adjustment
- Chrome plated
- 5/16" hex
- ~10" lg. x 3-1/4"
- Includes markings on tool indicating the point to STOP when making adjustments to the Pelton & Crane ceiling lights or unit lights

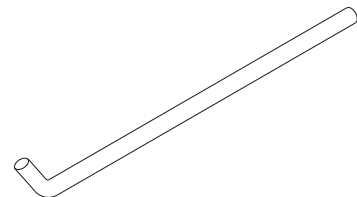

**RPI Part #BET029**

**ADJUSTMENT TOOL (SPRING TENSION)**

- Used to adjust spring tension and head position on the Belmont and Healthco X-Calibur models

PLASTIC & METAL TUBING SNAKES

**Plastic Tubing Snake**  
RPI Part #RPT620

1/4-20

Accessory Pouch (5" w x 4" h)  
RPI Part #RPP634

Bullet Tip (5/16" dia.)  
RPI Part #RPA627

Flexible Extension  
RPI Part #RPA625

**Metal Tubing Snake**  
RPI Part #RPT629

#10-32

Accessory Pouch (5" w x 4" h)  
RPI Part #RPP634

Bullet Tip (1/4" dia.)  
RPI Part #RPA633

PLASTIC TUBING SNAKE

RPI Part #RPT620

OEM Part #: (No OEM Part # Available)

- 15' of 3/16" dia. non-conductive fiberglass rod with PVC holder
- Includes Bullet Tip (RPI Part #RPA627), Flexible Extension (RPI Part #RPA625), and Accessory Pouch (RPI Part #RPP634)
- One end has fixed 3/16" dia. brass tip with 1/8" dia. hole; Opposite end has a 1/4-20 male thread adapter for adding attachments
- With Connector (RPI Part #RPA621), two Plastic Tubing Snakes can be joined together for those longer reach jobs
- Minimum bend radius: 2.5"



METAL TUBING SNAKE

RPI Part #RPT629

OEM Part#: (No OEM Part # Available)

- 12' of 1/8" dia. flex cable
- Includes Bullet Tip (RPI Part #RPA633), and Accessory Pouch (RPI Part #RPP634)
- One end has a fixed 3/16" dia. brass tip with 1/8" dia. hole; Opposite end has a #10-32 male thread adapter for adding attachments
- With Connector (RPI Part #RPA631), two Metal Snakes can be joined together for those longer reach jobs
- Minimum bend radius: 3/4"



FLEXIBLE EXTENSION

RPI Part #RPA625

• 3" long

Fits: Plastic Tubing Snake

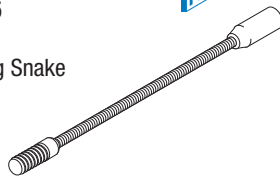

THE ATTACHMENTS SHOWN BELOW FIT BOTH SNAKES!

The Metal Snake requires the Adapter - RPI Part #RPA631

HOOK ATTACHMENT

RPI Part #RPA624

- 3-5/8" lg
- Hook: 1-1/8" wide with a .40" wide opening

Fits: Both Snakes (Metal Snake requires Adapter - RPI Part #RPA631)

PULLING EYE RING

RPI Part #RPA626

- 3/4" dia. pulling ring
- 5/16" dia. body

Fits: Both Snakes (Metal Snake requires Adapter - RPI Part #RPA631)

MAGNET ATTACHMENT

RPI Part #RPA622

- 15/32" dia. magnet tip
- Fits: Both Snakes (Metal Snake requires Adapter - RPI Part #RPA631)

ADAPTER

RPI Part #RPA631

- Allows a step-up for use with Plastic Snake attachments (Hook Attachment, Pulling Eye Ring, and Magnet Attachment)

Fits: Metal Snake

1/4-20 Male

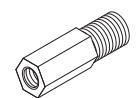

#10-32 Female



BULLET TIP (5/16" dia.)

RPI Part #RPA627

- 5/16" dia. body with 3/16" dia. hole

Fits: Plastic Tubing Snake



BULLET TIP (1/4" dia.)

RPI Part #RPA633

- 1/4" dia. body with 3/16" dia. hole

Fits: Metal Snake

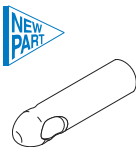

FIBER-OPTIC PULLER (5/16" dia.)

RPI Part #RPA623

- Includes (1) #6-32 x 3/32" lg set screw to lock fiber-optic tube in place
- 5/16" dia. Bullet Tip
- 1-3/8" lg.

Fits: Plastic Tubing Snake

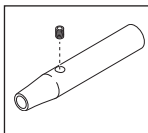

FIBER-OPTIC PULLER (1/4" dia.)

RPI Part #RPA630

- Includes (1) #6-32 x 3/32" lg. set screw to lock fiber-optic tube in place
- 1/4" dia. Bullet Tip
- 1-1/8" lg

Fits: Metal Snake

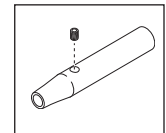

CONNECTOR (PLASTIC SNAKE)

RPI Part #RPA621

- Allows two Plastic Snakes to be connected for a 30' reach

Fits: Plastic Tubing Snake

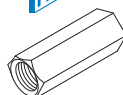

ACCESSORY POUCH

RPI Part #RPP634

- 5" w x 4" h
- 600 Denier Polyester
- Velcro® belt-loop flap

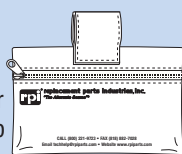

CONNECTOR (METAL SNAKE)

RPI Part #RPA632

- Allows two Metal Snakes to be connected for a 24' reach

Fits: Metal Snake

